



4AJ-0-0



Sylvania Type **0A3**
 Sylvania Type **0B3**
 Sylvania Type **0C3**
 Sylvania Type **0D3**

RATINGS

	0A3	0B3	0C3	0D3
Minimum Starting Voltage Required.....	105	125	133	185 Volts
Operating Current—Minimum.....	5	5	5	5 Ma.
Operating Current—Maximum.....	40	30	40	40 Ma.
Maximum Peak Current for 10 Seconds.....	100	100	100	100 Ma.

TYPICAL OPERATION

Heater Voltage.....	None Required			
Operating Voltage.....	75	90	105	150 Volts
Regulation (Maximum Voltage Change Minimum to Maximum Current).....	6.5	6	4	5.5 Volts



4V-0-0



Sylvania Type **0A4G**

COLD CATHODE CONTROL TUBE

PHYSICAL SPECIFICATIONS

Base.....	Small Octal 6-Pin
Bulb.....	ST-12
Maximum Overall Length.....	4 1/8"
Maximum Seated Height.....	3 3/8"
Mounting Position.....	Any

RATINGS

Min. Anode to Cathode Breakdown Voltage (Starter Anode Potential 0 Volts).....	225 Volts
Starter Anode to Cathode Breakdown Voltage—Min.....	70 Volts
Max.....	90 Volts
Max. Starter Anode Current for Anode Breakdown.....	100 μ a.
Starter Anode to Cathode Voltage Drop (Approx.).....	60 Volts
Anode to Cathode Voltage Drop (Approx.).....	70 Volts
Anode Current—Continuous Max.....	25 Ma.
Instantaneous Max.....	100 Ma.

TYPICAL OPERATION

Anode Supply Voltage (RMS).....	105 to 130 Volts
Starter Anode Voltage—Peak AC.....	70 Volts
Peak RF.....	55 Volts

Note: To assure stable operation, the 0A4G should be shielded from external light sources.

0A5 Sylvania Type

TRIGGER TUBE

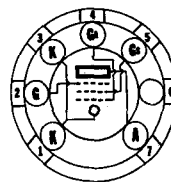

0A5

PHYSICAL SPECIFICATIONS

Base	Miniature Button 7 Pin
Bulb	T-5 1/2
Maximum Overall Length	1 1/2"
Maximum Seated Height	1 3/8"
Mounting Position	Any

RATINGS

Maximum Anode Operating Voltage DC	1000 Volts
Minimum Anode Operating Voltage DC (1)	500 Volts
Minimum Trigger Grid Firing Voltage (2)	+180 Volts
Minimum Hold-Off Voltage DC (3)	1500 Volts
Minimum Trigger Grid Pulse Voltage to Fire (2)	50 Volts
Maximum Trigger Grid Pulse Current (4)	40 μ a.
Maximum Discharge Capacitance	0.5 μ f.
Maximum Power Input (5)	1.0 Watt
Maximum Repetition Rate	See Note 5
Minimum Peak Cathode Current to Produce Arc	10 Amperes
Ambient Temperature Range	-40 to +60° C.

(1) Operation at 250 volts is possible providing higher trigger pulse voltages are available.

(2) This is the sum of bias voltage and triggering pulse.

(3) Voltages above this limit may cause the tube to fire without application of pulse voltage. Measured in a typical circuit with a trigger grid bias of 90 volts and a keep-alive current of 50 μ a.

(4) Measured in a typical circuit with 50 μ a keep-alive current and 90 volts trigger grid bias.

(5) The maximum power input is given by $W = \frac{1}{2} CV^2 f$ where C is the discharge capacitance in microfarads, V is the anode voltage in kilovolts and f is the number of flashes or pulses per second. This relation also determines the maximum repetition rate.

TYPICAL OPERATION

In an Electroflash Trigger Circuit

Anode Voltage DC	750 Volts
Trigger Grid Voltage	+90 Volts
Trigger Grid Circuit Resistance	0.25 Megohm
Trigger Pulse Voltage	85 Volts
Keep-Alive Current	50 μ a.
Discharge Condenser	0.25 μ f.

APPLICATION

Sylvania Type 0A5 is a miniature cold cathode gas discharge tube designed for use as a trigger tube for switching service requiring extremely high instantaneous peak currents (hundreds of amperes). It is sensitive enough and will carry high enough current to permit photocell operation of some devices without special amplifiers. The circuit below shows its use in a typical portable Electroflash unit, where its use reduces the current carrying capacity requirement of the switch and also reduces the shock hazard.

Note that for most applications the shield grid (Pin 5) is left floating. This increases the sensitivity. Connection to the cathode through a 10 meg. resistor increases the hold-off voltage considerably, but a higher trigger grid current will be required.

Sylvania Type 0A5 is manufactured under license granted by Edgerton, Germeshausen, and Grier, but no license is granted nor is a license to be implied under their circuit patents.

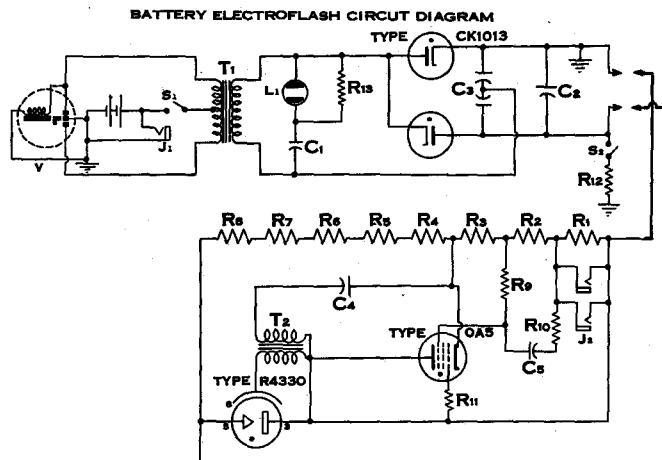
**PARTS LIST**

Condenser	Capacity	Working Voltage	Resistor	Ohms	Watts
C1	.001 μ d.	2500	R12	5000	10
C2	32 μ d.	2500	R13	47,000	$\frac{1}{2}$
C3	.05 - .05 μ d.	2000			
C4	.25 μ d.	1000			
C5	.01 μ d.	600			
Resistor	Ohms	Watts	Battery	MISCELLANEOUS	
R1	.51 Meg.	$\frac{1}{2}$	J1	4 Volt Storage	
R2	1.8 Meg.	$\frac{1}{2}$	J2	Battery charging connection	
R3	.47 Meg.	$\frac{1}{2}$	L1	Camera and Synchronizer connection	
R4 to R8	1.6 Meg. each	1	S1	Neon Indicator Lamp	
R9	10 Meg.	$\frac{1}{2}$	S2	Off-On switch S.P.S.T.	
R10	.27 Meg.	$\frac{1}{2}$	T1	Safety switch	
R11	10 Meg.	$\frac{1}{2}$	T2	Vibrator Transformer	
			V	Vibrator	



4AJ-0-0



Sylvania Type OB3
Sylvania Type OC3
Sylvania Type OD3

VOLTAGE REGULATORS

(SEE TYPE OA3 FOR SPECIFICATIONS AND RATINGS)

OZ4 Sylvania Type OZ4G Sylvania Type

FULL WAVE GAS RECTIFIERS

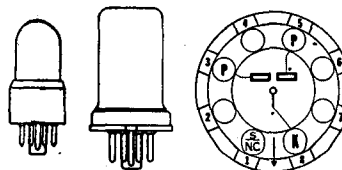

4R-1-0 (OZ4)
4R-0-0 (OZ4G)

PHYSICAL SPECIFICATIONS

	OZ4	OZ4G
Base.....	Small Wafer Octal 6 Pin	Dwarf Octal 5 Pin
Bulb.....	Metal 8-3	T-7
Maximum Overall Length.....	2 5/8"	2 3/4"
Maximum Seated Height.....	2 1/16"	2 1/16"
Mounting Position.....	Any	Any

RATINGS

Heater Voltage.....	None Required
Peak Starting Plate Voltage.....	300 Min.
Peak Plate Current (Operating).....	200 Ma.
Peak Plate to Plate Voltage.....	1000 Volts
DC Output Current.....	30 Ma. Min. 90 Ma. Max

TYPICAL OPERATION

Heater Voltage.....	None Required
AC Plate Voltage (RMS).....	300 Volts
DC Output Current.....	90 Ma.

1A5GT Sylvania Type

POWER AMPLIFIER PENTODE

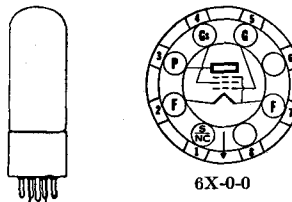

6X-0-0

PHYSICAL SPECIFICATIONS

	Intermediate	Octal 7-Pin
Base.....		
Bulb.....		T-9
Maximum Overall Length.....		3 3/8"
Maximum Seated Height.....		2 3/4"
Mounting Position.....		Any

RATINGS

Maximum Filament Voltage.....	1.6 Volts
Filament Voltage (Design Center for AC-DC Oper.).....	1.3 Volts
Maximum Plate Voltage.....	110 Volts
Maximum Screen Voltage.....	110 Volts
Maximum Total Zero Signal Cathode Current.....	6 Ma.

TYPICAL OPERATION AS A CLASS A₁ AMPLIFIER

Filament Voltage.....	1.4	1.4 Volts
Filament Current.....	.050	.050 Ampere
Plate Voltage.....	85	90 Volts
Screen Voltage.....	85	90 Volts
Grid Voltage*.....	-4.5	-4.5 Volts
Plate Current.....	3.5	4.0 Ma.
Screen Current.....	0.7	0.8 Ma.
Plate Resistance.....	0.3	0.3 Megohm
Mutual Conductance.....	800	850 μmhos
Load Resistance.....	25,000	25,000 Ohms
Power Output.....	100	115 Milliwatts
Total Harmonic Distortion.....	10	7 Percent

*Self bias is recommended for battery operation although it reduces the power output slightly. It makes a separate bias supply unnecessary and allows the bias to decrease in proportion with the decrease in B supply volts with age.



7Z-1-0



Sylvania Type 1A7^{GT}

HEPTODE CONVERTER

PHYSICAL SPECIFICATIONS

Base.....	Small Wafer Octal 8-Pin Metal Sleeve
Bulb.....	T-9
Cap.....	Miniature
Maximum Overall Length.....	3 $\frac{3}{4}$ "
Maximum Seated Height.....	2 $\frac{1}{4}$ "
Mounting Position.....	Any

RATINGS

Filament Voltage.....	1.4 Volts
Filament Current.....	0.05 Ampere
Maximum Plate Voltage.....	110 Volts
Maximum Screen Voltage.....	60 Volts
Maximum Screen Supply Voltage.....	110 Volts
Maximum Anode-Grid Voltage.....	110 Volts
Maximum Cathode Current.....	4.0 Ma.

TYPICAL OPERATION

Filament Voltage.....	1.4 Volts
Filament Current.....	0.05 Ampere
Plate Voltage.....	90 Volts
Screen Voltage**.....	45 Volts
Anode-Grid Voltage.....	90 Volts
Control-Grid Voltage (G) [†]	0 Volts
Oscillator Grid Resistor (Go).....	200000 Ohms
Plate Resistance.....	0.6 Megohm
Plate Current.....	0.55 Ma.
Screen Current.....	0.6 Ma.
Anode-Grid Current.....	1.2 Ma.
Oscillator Grid Current.....	0.035 Ma.
Total Cathode Current.....	2.4 Ma.
Conversion Conductance:	
Control Grid Voltage at 0 Volts.....	250 μ hos
Control Grid Voltage at -2 Volts.....	50 μ hos
Control Grid Voltage at -3 Volts.....	5 μ hos

**Obtained preferably by using a properly by-passed 70,000 ohm resistor in series with a 90 volt supply.

[†]A resistance of at least 1 megohm should be in the grid return to negative filament pin.

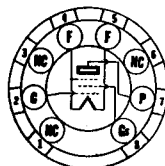

8CP-0-0



Sylvania Type 1AC5

OUTPUT PENTODE

PHYSICAL SPECIFICATIONS

Base.....	Subminiature Button 8 Pin
Bulb.....	T-3
Maximum Overall Length.....	1 $\frac{3}{4}$ "
Maximum Seated Height.....	1 $\frac{1}{2}$ "
Mounting Position.....	Any

RATINGS

Filament Voltage DC.....	1.25 Volts
Maximum Plate Voltage.....	67.5 Volts
Maximum Screen Voltage.....	67.5 Volts
Maximum Cathode Current.....	4.0 Ma.

1AC5 (Cont.)

TYPICAL OPERATION

CLASS A AMPLIFIER

Filament Voltage DC	1.25	1.25	1.25 Volts
Filament Current	40	40	40 Ma.
Plate Voltage	30	45	67.5 Volts
Screen Voltage	30	45	67.5 Volts
Grid Voltage	-2.0	-3.0	-4.5 Volts
Plate Current	0.50	1.0	2.0 Ma.
Screen Current	0.10	0.2	0.4 Ma.
Plate Resistance (Approx.)	.200	.170	.150 Megohm
Mutual Conductance	450	600	750 μ mhos
Load Resistance	50,000	40,000	25,000 Ohms
Power Output	5	15	50
Total Harmonic Distortion	10	10	10%

APPLICATION

Sylvania Type 1AC5 is an Output Pentode suitable for use in very small radio sets or amplifiers. The other types required for a normal set complement and designed for such usage are Types 1E8 (Converter), 1T6 (Diode Pentode) and 1AD5 (RF Pentode).

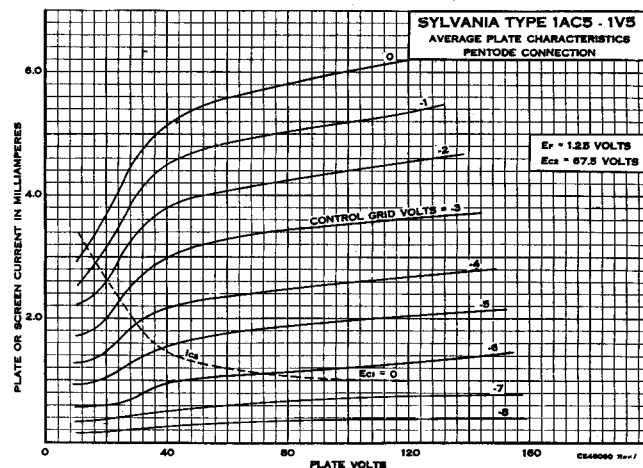
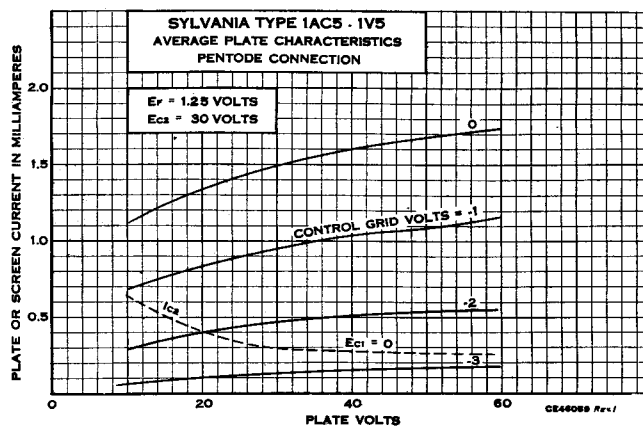



8CP-0-0



Sylvania Type 1AD5

SHARP CUT-OFF RF PENTODE

PHYSICAL SPECIFICATIONS

Base	Subminiature Button 8 Pin
Bulb	T-3
Maximum Overall Length	1 3/4"
Maximum Seated Height	1 1/2"
Mounting Position	Any

Direct Interelectrode Capacitances:*

	Unshielded	Shielded*
Grid to Plate01 Max.	.009 μ f. Max.
Input	1.8	1.9 μ f.
Output	2.8	3.0 μ f.

*With 0.405" diameter shield connected to negative filament. Leads numbering 1, 3 and 6 must be grounded to obtain these values.

TYPICAL OPERATION

Filament Voltage DC	1.25	1.25	1.25 Volts
Filament Current	40	40	40 Ma.
Plate Voltage	30	45	67.5 Volts
Screen Voltage	30	45	67.5 Volts
Grid Voltage	0	0	0 Volts
Plate Current	0.45	0.9	1.85 Ma.
Screen Current	0.18	0.35	0.75 Ma.
Plate Resistance (Approx.)	0.7	0.7	0.7 Megohm
Mutual Conductance	430	580	735 μ mhos
Control Grid Voltage for $I_b = 10 \mu$ a. (Approx.)	-3.0	-4.0	-6.0 Volts

APPLICATION

Sylvania Type 1AD5 is an RF Pentode tube suitable for use in very small radio sets or amplifiers. The other types required for a normal set complement and designed for such usage are Types 1E8 (Converter), 1T6 (Diode Pentode) and 1AC5 (Output Pentode).

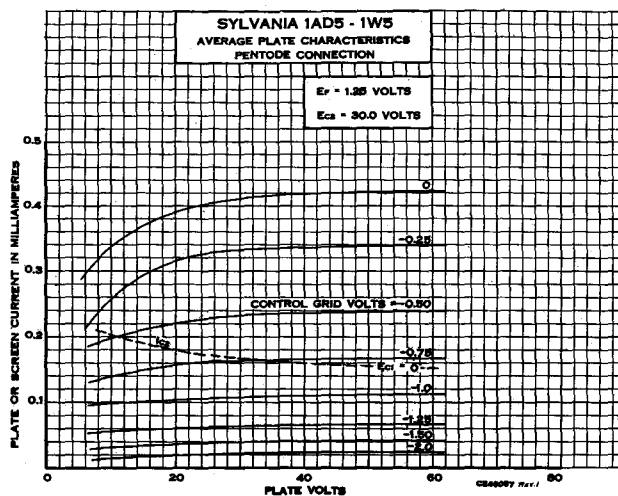

1AD5 (Cont'd)

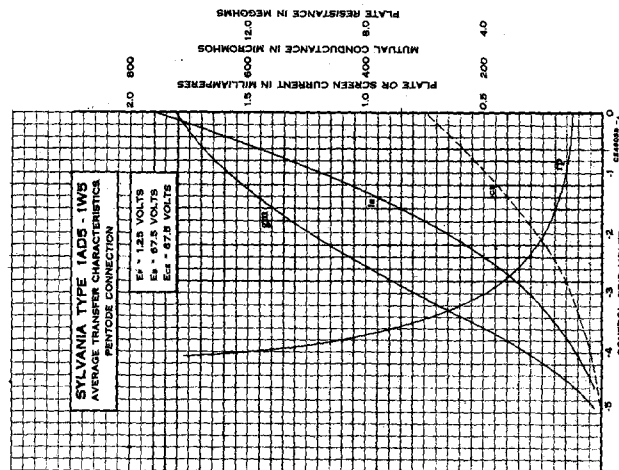
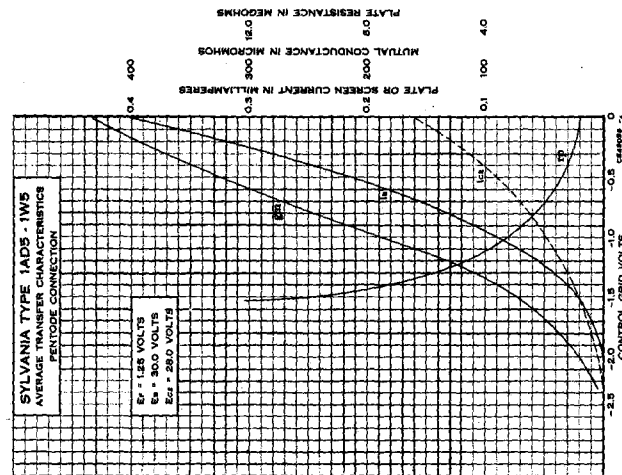
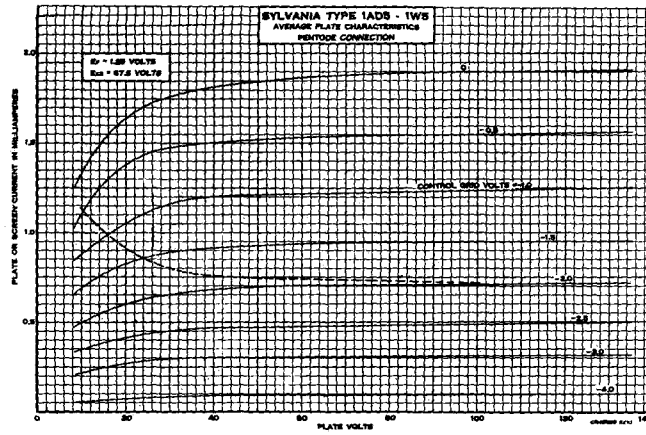

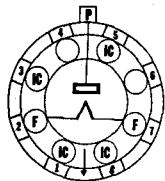

3C-0-7



Sylvania Type 1B3^{GT}

HALF-WAVE RECTIFIER

PHYSICAL SPECIFICATIONS

Base.....	Short Intermediate Shell Octal 6-Pin
Bulb.....	T-9
Cap.....	Small
Maximum Overall Length.....	4 $\frac{1}{16}$ "
Maximum Seated Height.....	3 $\frac{1}{2}$ "
Mounting Position.....	Any

RATINGS

Filament Voltage AC or DC.....	1.25 Volts
Filament Current.....	200 Ma.
Maximum Peak Inverse Plate Voltage.....	30,000 Volts
Maximum Peak Plate Current.....	17 Ma.
Maximum Average Plate Current.....	2 Ma.
Maximum Frequency of Supply Voltage.....	300 Kc.

Direct Interelectrode Capacitances*

Plate to Filament (Approx.).....	1.2 μ f.
----------------------------------	--------------

* Unshielded.

APPLICATION

Sylvania Type 1B3GT is a high-vacuum half-wave rectifier designed for high voltage service where low currents are required. Typical examples are for operation of cathode-ray tubes and electroflash units.

When the high voltage is supplied by an oscillator care should be taken to use large leads and long radius corners to avoid corona loss. When the filament is also supplied by the oscillator the adjustment for proper operating temperature should be made optically by comparison with a similar filament on a readily metered supply.

WARNING

The voltages employed in some television receivers and other high voltage equipment are sufficiently high that high-voltage rectifier tubes may produce X-rays which can constitute a health hazard, unless such tubes are adequately shielded.



6X-0-0



Sylvania Type 1C5^{GT}

POWER OUTPUT PENTODE

PHYSICAL SPECIFICATIONS

Base.....	Intermediate Octal 7-Pin
Bulb.....	T-9
Maximum Overall Length.....	3 $\frac{1}{4}$ "
Maximum Seated Height.....	2 $\frac{1}{4}$ "
Mounting Position.....	Any

TYPICAL OPERATION

Filament Voltage.....	1.4	1.4 Volts
Filament Current.....	0.10	0.10 Ampere
Plate Voltage.....	83	90 Volts
Screen Voltage.....	83	90 Volts
Grid Voltage*.....	-7.0	-7.5 Volts
Plate Current.....	7.0	7.5 Ma.
Screen Current.....	1.6	1.6 Ma.
Plate Resistance.....	110000	115000 Ohms
Mutual Conductance.....	1500	1550 μ mhos
Amplification Factor.....	165	180
Load Resistance.....	9000	8000 Ohms
Power Output.....	200	240 Mw.
Total Harmonic Distortion.....	10	10 Per Cent

*Negative filament return, Pin No. 7.

1C8 Sylvania Type

PENTAGRID CONVERTER

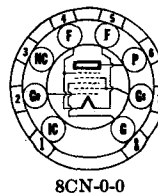

8CN-0-0

PHYSICAL SPECIFICATIONS

Base	Flexible Leads
Bulb	T-3
Maximum Bulb Length	1 1/2"
Minimum Lead Length	1 1/4"
Mounting Position	Any

For additional data reference should be made to Type 1E8 which has the same operating conditions but differs in lead length.

1D21 Sylvania Type

STROBOTRON

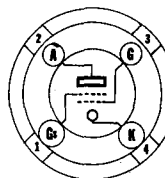

1D21

PHYSICAL SPECIFICATIONS

Base	Small 4 Pin
Bulb	T-9
Maximum Overall Length	4 1/2"
Maximum Seated Height	3 3/8"
Mounting Position	Any

RATINGS

Maximum Anode Voltage DC*	300 Volts
Maximum Peak Inverse Anode Voltage	50 Volts
Minimum Peak Cathode Current	5 Amperes
Maximum Average Cathode Current	50 Ma.
Maximum Pulse Frequency	240 pps
Maximum Average Grid Current	15 Ma.
Maximum Control Grid Circuit Resistance	5 Megohms
Maximum Grid Current (Surge)	1 Ma.
Maximum Shield or Control Grid Voltage†	±50 Volts
Minimum Grid Pulse Voltage	175 Volts
Approx. Tube Voltage Drop—Glow Discharge	70 Volts
—Arc Discharge	20 Volts
Ambient Temperature Range	-55 to +90° Cent.

TYPICAL OPERATION

Anode Voltage*	300 Volts
Average Cathode Current	50 Ma.
Peak Cathode Current	10 to 200 Amperes
Control Grid Voltage†	0 Volts
Shield Grid Voltage†	+30 Volts
Pulse Voltage	175 Volts

*Measured from anode to shield grid.

†Either grid may be used for control with proper bias on the other grid.

APPLICATION

Sylvania Strobotron Type 1D21 is a gas discharge tube which when used in a suitable circuit may be used for studying the motion of rotating or reciprocating parts up to 14,400 revolutions per minute.

A circuit for a simple stroboscope requiring a minimum of parts and capable of operating over the range from 600 to 6720 revolutions per minute is shown below.

Sylvania Strobotron tubes are manufactured under license granted by Edgerton, Germeshausen, and Grier, but no license is granted nor is a license to be implied under their circuit patents.

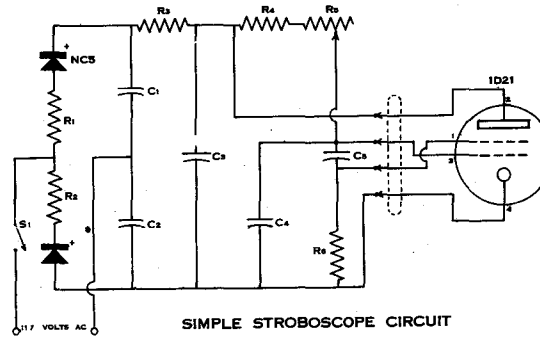

PARTS LIST

R1—10 ohm, 1 w. res.	C1—20 μ d., 450 v. elec. cond.
R2—10 ohm, 1 w. res.	C2—20 μ d., 450 v. elec. cond.
R3—3500 ohm, 10 w. wirewound res.	C3—1 μ d., 400 v. cond.
R4—50,000 ohm, 1 w. res.	C4—1 μ d., 400 v. cond.
R5—1 megohm pot.	C5—.01 μ d., mica cond.
R6—2 megohm, 1 w. res.	S1—S.p.s.t. toggle sw.

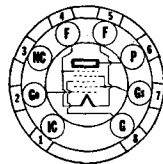

8CN-0-0



Sylvania Type 1E8

PENTAGRID CONVERTER

PHYSICAL SPECIFICATIONS

Base.....	Subminiature Button 8 Pin
Bulb.....	T-3
Maximum Overall Length.....	1 3/4"
Maximum Seated Height.....	1 1/2"
Mounting Position.....	Any

Direct Interelectrode Capacitances:

	Unshielded
Control grid to all other electrodes.....	6.0 μ f.
Control grid to plate.....	0.4 μ f. Max.
Plate to all other electrodes.....	5.0 μ f.
Oscillator grid to control grid.....	0.2 μ f. Max.
Oscillator grid to all other electrodes.....	2.4 μ f.

TYPICAL OPERATION

Filament Voltage DC.....	1.25	1.25	1.25 Volts
Filament Current.....	40	40	40 Ma.
Plate Voltage.....	30	45	67.5 Volts
Screen Supply Voltage.....	30	45	67.5 Volts
Screen Grid Resistor.....	10,000	15,000	20,000 Ohms
Grid Voltage.....	0	0	0 Volts
Plate Current.....	0.30	0.6	1.0 Ma.
Screen Current.....	0.8	1.1	1.5 Ma.
Plate Resistance (Approx.).....	0.3	0.4	0.4 Megohm
Conversion Transconductance.....	115	140	150 μ mhos
Oscillator Grid Resistance.....	0.1	0.1	0.1 Megohm
Oscillator Grid Current.....	30	50	70 μ a.
Control Grid Voltage for $G_c=5 \mu$ mhos approx.....	-7.0	-8.0	-9.0

Oscillator Characteristics*

Mutual Conductance..... 730 μ mhos

*In a non-oscillating condition with plate and screen tied together at a voltage of 30 volts, and zero volts on the oscillator and control grids.

APPLICATION

Sylvania Type 1E8 is a converter tube for use in very small radio sets. The other types required for a normal set complement and designed for such usage are Types 1T6 (Diode Pentode), 1AC5 (Output Pentode) and 1AD5 (RF Pentode).

This type corresponds in service and circuit requirements to Type 1R5 except for optimization of the performance at low voltages.

1G4^{GT} Sylvania Type

MEDIUM-MU TRIODE

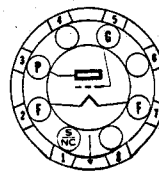

5S-0-0

PHYSICAL SPECIFICATIONS

Base.....	Intermediate Octal 7 Pin
Bulb.....	T-9
Maximum Overall Length.....	3 ⁵ / ₁₆ "
Maximum Seated Height.....	2 ³ / ₄ "
Mounting Position.....	Any

TYPICAL OPERATION

Filament Voltage DC.....	1.4 Volts
Filament Current.....	50 Ma.
Plate Voltage.....	90 Volts Max.
Grid Voltage*.....	-6.0 Volts
Plate Current.....	2.3 Ma.
Mutual Conductance.....	825 μ mhos
Amplification Factor.....	8.8

*Negative filament return, Pin No. 7.

1G6^{GT} Sylvania Type

DUO TRIODE POWER AMPLIFIER

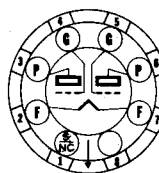
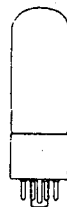

7AB-0-0

PHYSICAL SPECIFICATIONS

Base.....	Intermediate Octal 7 Pin
Bulb.....	T-9
Maximum Overall Length.....	3 ⁵ / ₁₆ "
Maximum Seated Height.....	2 ³ / ₄ "
Mounting Position.....	Any

TYPICAL OPERATION

Filament Voltage DC.....	1.4 Volts
Filament Current.....	100 Ma.

CLASS A AMPLIFIER (Each Triode)

Plate Voltage.....	90 Volts
Grid Voltage.....	0 Volt
Plate Current.....	1.0 Ma.
Plate Resistance.....	40000 Ohms
Mutual Conductance.....	825 μ mhos
Amplification Factor.....	33

CLASS B POWER AMPLIFIER

Plate Voltage.....	90 Volts Max.
Grid Voltage.....	0 Volt
Plate Current Per Plate (Zero Signal).....	1.0 Ma.
Peak Plate Current Per Triode.....	20 Ma. Max.
Load Resistance (Plate to Plate).....	12000 Ohms
Power Output*.....	675 Mw.
Distortion (Approx.).....	3 Per Cent

1H5^{GT} Sylvania Type

DIODE HIGH-MU TRIODE

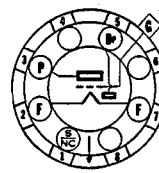

5Z-1-7

PHYSICAL SPECIFICATIONS

Base.....	Small Wafer 7 Pin Octal Metal Sleeve
Bulb.....	T-9
Cap.....	Miniature
Maximum Overall Length.....	3 ⁵ / ₁₆ "
Maximum Seated Height.....	2 ³ / ₄ "
Mounting Position.....	Any

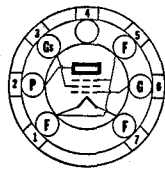

6AR-0-1 & 5



Sylvania Type 1L4

SHARP CUT-OFF RF PENTODE

PHYSICAL SPECIFICATIONS

Base.....	Miniature Button 7 Pin
Bulb.....	T-5 1/2"
Maximum Overall Length.....	2 1/8"
Maximum Seated Height.....	1 1/8"
Mounting Position.....	Any

RATINGS

Filament Voltage	
Battery Operation—Must Never Exceed.....	1.6 Volts
AC DC Power Line Operation—Design Center.....	1.3 Volts
Maximum Plate Voltage.....	110 Volts
Maximum Screen Voltage.....	90 Volts
Maximum Total Cathode Current.....	6.5 Ma.
Minimum Grid Bias.....	0 Volt

Direct Interelectrode Capacitances:*

Grid to Plate.....	0.010 $\mu\mu\text{f}$ Max.
Input.....	3.6 $\mu\mu\text{f}$
Output.....	7.5 $\mu\mu\text{f}$

*Measured without tube shield.

TYPICAL OPERATION

Filament Voltage DC.....	1.4	1.4 Volts
Filament Current.....	50	50 Ma.
Plate Voltage.....	90	90 Volts
Screen Voltage.....	67.5	90 Volts
Grid Voltage.....	0	0 Volts
Plate Resistance.....	0.6	0.35 Megohm
Mutual Conductance.....	925	1025 μmbos
Plate Current.....	2.9	4.5 Ma.
Screen Current.....	1.2	2.0 Ma.
Grid Bias for 10 μa . Plate Current.....	-6.0	-8.0 Volts

For use in resistance coupled amplifiers see appendix.

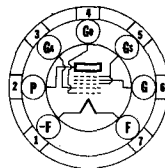

7DC-0-0



Sylvania Type 1L6

PENTAGRID CONVERTER

PHYSICAL SPECIFICATIONS

Base.....	Small Button 7 Pin
Bulb.....	T5 1/2"
Maximum Overall Length.....	2 1/8"
Maximum Seated Height.....	1 1/8"
Mounting Position.....	Any

RATINGS

Filament Voltage DC.....	1.4 Volts
Filament Current.....	50 Ma.
Maximum Plate Voltage.....	110 Volts
Maximum Screen Supply Voltage.....	110 Volts
Maximum Screen Voltage.....	65 Volts
Maximum Anode Grid Voltage.....	110 Volts
Maximum Cathode Current.....	4.0 Ma.
Minimum Signal Grid Circuit Resistance.....	1.0 Megohm

1L6 (Cont'd)

Direct Interelectrode Capacitances:

	Shielded*	Unshielded
Grid G to Plate	0.30	0.45 μf Max.
Grid G to Grid Ga	0.24	0.24 μf
Grid G to Grid Go	0.19	0.19 μf
Grid Go to Grid Ga	0.80	0.80 μf
Grid G to All (RF Input)	7.5	7.5 μf
Grid Ga to All except Go (Oscillator Output)	2.6	2.6 μf
Grid Go to All except Ga (Oscillator Input)	2.2	2.2 μf
Plate to All (Mixer Output)	12.0	7.0 μf
Grid Go to Plate	0.10	0.15 μf Max.

*With $\frac{3}{4}$ " diameter shield (RMA Std. 316) connected to Pin 1.

TYPICAL OPERATION

Filament Voltage	1.4 Volts
Filament Current	50 Ma.
Plate Voltage	90 Volts
Screen Voltage [#]	45 Volts
Anode Grid Voltage (Ega)	90 Volts
Control Grid Voltage	0 Volts
Control Grid Circuit Resistance	1.0 Megohm
Oscillator Grid Resistor (Rgo)	0.2 Megohm
Plate Resistance (Approx.)	0.65 Megohm
Plate Current	0.5 Ma.
Screen Current	0.6 Ma.
Anode Grid Current	1.2 Ma.
Oscillator Grid Current	0.035 Ma.
Total Cathode Current	2.35 Ma.
Conversion Transconductance	
Control Grid Voltage at 0 Volts	300 μmhos
Control Grid Voltage at -3.5 Volts (Approx.)	10 μmhos
Oscillator Mutual Conductance**	550 μmhos

**Not oscillating, $E_b = 90$ V, $E_{gs} = 45$ V, $E_{ga} = 90$ V, E_g and $E_{go} = 0$ V.
[#]Obtained preferably by using a properly bypassed dropping resistor of from 45,000 ohms to 75,000 ohms in series with the B supply.

APPLICATION

Sylvania Type 1L6 is a miniature type pentagrid converter designed for use in low drain battery operated receivers. It is similar in construction and application to Types 1A7GT and 1LA6. The small size and low current requirements recommend it for use in small portable receivers.

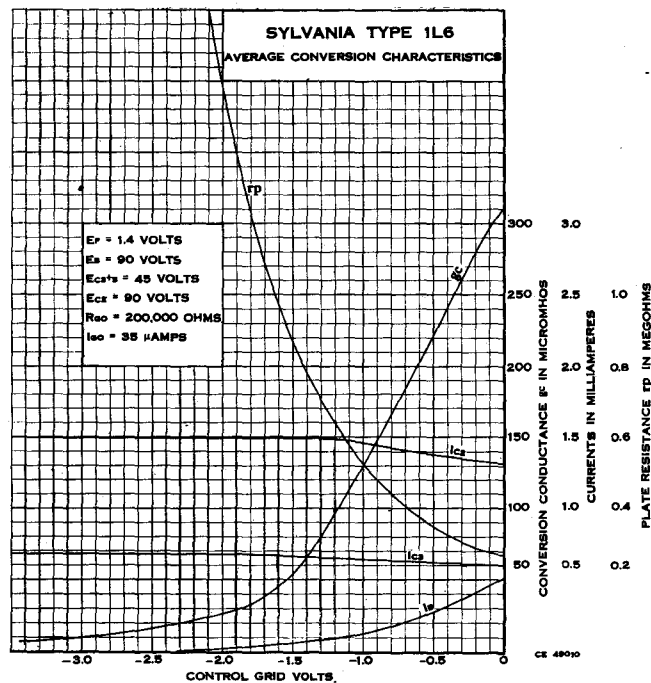

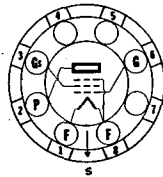
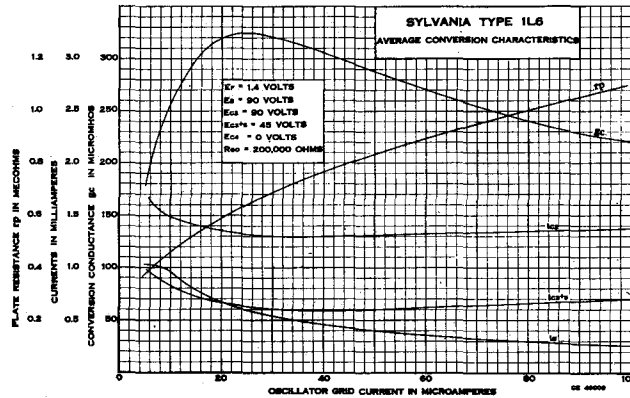

5AD-L-0

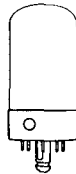

Sylvania Type 1LA4

POWER OUTPUT PENTODE

PHYSICAL SPECIFICATIONS

Base.....	Lock-In 8 Pin
Bulb.....	T-9
Maximum Overall Length.....	2 ³⁵ / ₁₆ "
Maximum Seated Height.....	2 1/4"
Mounting Position.....	Any

RATINGS

Maximum Filament Voltage.....	1.6 Volts
Filament Voltage (Design Center for AC-DC Operation).....	1.3 Volts
Maximum Plate Voltage.....	110 Volts
Maximum Screen Voltage.....	110 Volts
Maximum Total Zero Signal Cathode Current.....	6 Ma.

TYPICAL OPERATION AS A CLASS A₁ AMPLIFIER

Filament Voltage DC.....	1.4	1.4 Volts
Filament Current.....	50	50 Ma.
Plate Voltage.....	85	90 Volts
Screen Voltage.....	85	90 Volts
Grid Volts*.....	-4.5	-4.5 Volts
Self-Bias Resistor*.....	1000	950 Ohms
Plate Current.....	3.5	4.0 Ma.
Screen Current.....	0.7	0.8 Ma.
Plate Resistance.....	0.3	0.3 Megohm
Mutual Conductance.....	800	850 μ mhos
Load Resistance.....	25,000	25,000 Ohms
Power Output.....	100	115 Milliwatts
Total Harmonic Distortion.....	10	7 Per Cent

*Self bias is recommended for battery operation. Although it reduces the power output slightly it makes a separate bias supply unnecessary and allows the bias to decrease in proportion with the decrease in B supply volts with age.



7AK-L-0

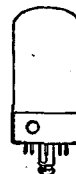

Sylvania Type 1LA6

HEPTODE CONVERTER

PHYSICAL SPECIFICATIONS

Base.....	Lock-In 8 Pin
Bulb.....	T-9
Maximum Overall Length.....	2 ³⁵ / ₁₆ "
Maximum Seated Height.....	2 1/4"
Mounting Position.....	Any

SYLVANIA RADIO TUBES

1LA6 (Cont'd)

RATINGS

Maximum Filament Voltage.....	1.6 Volts
Design Center for AC-DC Operation.....	1.3 Volts
Maximum Plate Voltage.....	110 Volts
Maximum Screen Supply.....	110 Volts
Maximum Screen Voltage.....	65 Volts
Maximum Anode-Grid Voltage.....	110 Volts
Maximum Cathode Current.....	4.0 Ma.

Direct Interelectrode Capacitances:*

Grid G to Plate.....	0.4 μ f
Mixer Input.....	7.5 μ f
Mixer Output.....	8.0 μ f
Oscillator Input.....	2.8 μ f
Oscillator Output.....	3.2 μ f

*With 1 $\frac{1}{8}$ " diameter tube shield (RMA Std. 308) connected to negative filament.

TYPICAL OPERATION

Filament Voltage DC.....	1.4 Volts
Filament Current.....	50 Ma.
Plate Voltage.....	90 Volts
Screen Voltage**.....	45 Volts
Anode-Grid Voltage.....	90 Volts
Control Grid Voltage (G).....	0 Volt
Oscillator Grid Resistor (Go).....	200000 Ohms
Plate Resistance.....	0.75 Megohm
Plate Current.....	0.55 Ma.
Screen Current.....	0.6 Ma.
Anode-Grid Current.....	1.2 Ma.
Oscillator Grid Current.....	0.035 Ma.
Conversion Conductance.....	250 μ mhos
Control Grid Voltage at -3 Volts.....	10 μ mhos

**Obtained preferably by using a properly by-passed voltage dropping resistor of 45,000 to 70,000 ohms in series with the "B" voltage supply.

A resistance of at least 1 megohm should be in the grid return to negative fil.

1LB4 Sylvania Type

POWER OUTPUT PENTODE

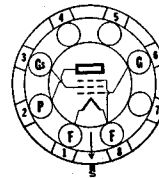
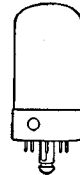

5AD-L-0

PHYSICAL SPECIFICATIONS

Base.....	Lock-In 8 Pin
Bulb.....	T-9
Maximum Overall Length.....	2 $\frac{3}{4}$ "
Maximum Seated Height.....	2 $\frac{1}{4}$ "
Mounting Position.....	Any

RATINGS

Maximum Filament Voltage.....	1.6 Volts
Design Center for AC-DC Operation.....	1.3 Volts
Maximum Plate Voltage.....	110 Volts
Maximum Screen Voltage.....	110 Volts
Maximum Cathode Current.....	6.0 Ma.

TYPICAL OPERATION

Filament Voltage DC.....	1.4	1.4	1.4	1.4 Volts
Filament Current.....	50	50	50	50 Ma.
Plate Voltage.....	45	62.5	67.5	90 Volts
Screen Voltage.....	45	62.5	67.5	90 Volts
Grid Voltage.....	-4.5	-5.0	-6.0	-9.0 Volts
Plate Current (Zero Signal).....	1.6	3.8	3.8	5.0 Ma.
Screen Current (Zero Signal).....	0.3	0.8	0.8	1.0 Ma.
Plate Resistance (Approx.).....	0.4	0.3	0.3	0.25 Megohm
Mutual Conductance.....	650	875	875	925 μ mhos
Load Resistance.....	20000	16000	16000	12000 Ohms
Power Output.....	35	90	100	200 Mw.
Total Harmonic Distortion.....	10	10	10	10 Per Cent



7AO-L-8

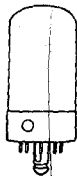

Sylvania Type 1L

SHARP CUT-OFF RF PENTODE

PHYSICAL SPECIFICATIONS

Base.....	Lock-In 8 Pin
Bulb.....	T-9
Maximum Overall Length.....	2 ³ / ₈ "
Maximum Seated Height.....	2 ¹ / ₄ "
Mounting Position.....	Any

RATINGS

Maximum Filament Voltage.....	1.6 Volts
Design Center for AC-DC Operation.....	1.3 Volts
Maximum Plate Voltage.....	110 Volts
Maximum Screen Voltage.....	45 Volts

Direct Interelectrode Capacitances:*

Grid to Plate.....	0.007 μ f Max.
Input.....	3.2 μ f
Output.....	7.0 μ f

*With 1⁵/₁₆" diameter shield (RMA Std. 308) connected to negative filament

TYPICAL OPERATION

Filament Voltage DC.....	1.4	1.4 Volts
Filament Current.....	50	50 Ma.
Plate Voltage.....	45	90 Volts
Screen Voltage.....	45	45 Volts
Grid Voltage*.....	0	0 Volt
Suppressor.....	Connected to Negative Filament at Socket	
Plate Current.....	1.1	1.15 Ma.
Screen Current.....	.35	.30 Ma.
Plate Resistance.....	0.7	1.5 Megohm Approx.
Mutual Conductance.....	750	775 μ mhos
Grid Voltage for $I_b=10 \mu$ a.....	-3.4	-3.4 Volts

*A resistance of at least 1 megohm should be in the grid return to negative filament Pin No. 8.

For data on use as a resistance coupled amplifier see appendix.



7AK-L-0



Sylvania Type 1LC6

HEPTODE CONVERTER

PHYSICAL SPECIFICATIONS

Base.....	Lock-In 8 Pin
Bulb.....	T-9
Maximum Overall Length.....	2 ³ / ₈ "
Maximum Seated Height.....	2 ¹ / ₄ "
Mounting Position.....	Any

RATINGS

Maximum Filament Voltage.....	1.6 Volts
Design Center for AC-DC Operation.....	1.3 Volts
Maximum Plate Voltage.....	110 Volts
Maximum Screen or Anode Grid Supply.....	110 Volts
Maximum Anode-Grid Voltage.....	50 Volts
Maximum Screen Grid Voltage.....	45 Volts
Maximum Cathode Current.....	3.0 Ma.

Direct Interelectrode Capacitances:*

Grid G to Plate.....	0.28 μ f.
Mixer Input.....	9.00 μ f.
Mixer Output.....	5.50 μ f.
Oscillator Input.....	2.40 μ f.
Oscillator Output.....	4.80 μ f.

*With 1⁵/₁₆" dia. tube shield (RMA Std. M8-308) connected to negative filament.

1LC6 (Cont'd)

TYPICAL OPERATION

Filament Voltage.....	1.4	1.4 Volts
Filament Current.....	0.050	0.050 Ampere
Plate Voltage.....	45	90 Volts
Screen Voltage*.....	35	35 Volts
Anode-Grid Voltage.....	45	45 Volts
Control Grid Voltage.....	0	0 Volt
Oscillator Grid Resistor.....	200000	200000 Ohms
Plate Resistance.....	300000	650000 Ohms
Plate Current.....	0.7	0.75 Ma.
Screen Current.....	0.75	0.70 Ma.
Anode-Grid Current.....	1.4	1.4 Ma.
Oscillator Grid Current.....	0.035	0.035 Ma.
Total Cathode Current.....	2.9	2.9 Ma.
Conversion Conductance:		
At 0 Volts.....	250	275 μ mhos
At -2 Volts.....	50	50 μ mhos
At -3 Volts.....	5	5 μ mhos approx.

*Obtained preferably by using a properly by-passed voltage dropping resistor in series with E voltage supply. In order to avoid oscillation difficulties the screen voltage must be at least 10 volts lower than the oscillator anode.

†A resistance of at least 1 megohm should be in the grid return to negative filament, Pin No. 8.

Note: The characteristics of the oscillator section (not oscillating) are; GM=550 μ mhos (approx.), MU=14, and anode-grid current=2.7 ma. Conditions; Ep=90 volts, Ega=45 volts, Egs=35 volts, and Ego and Egi=0 volts.

1LD5 Sylvania Type

DIODE PENTODE

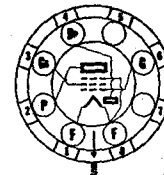
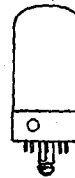

6AX-L-8

PHYSICAL SPECIFICATIONS

Base.....	Lock-In 8 Pin
Bulb.....	T-9
Maximum Overall Length.....	2 ³¹ / ₁₆ "
Maximum Seated Height.....	2 ¹ / ₄ "
Mounting Position.....	Any

RATINGS

Maximum Filament Voltage.....	1.6 Volts
Design Center for AC-DC Operation.....	1.3 Volts
Maximum Plate Voltage.....	110 Volts
Maximum Screen Voltage.....	50 Volts
Maximum Diode Drop for 0.5 Ma.....	10 Volts

Diode plate located at negative end of filament.

Direct Interelectrode Capacitances:*

Grid to Plate.....	0.18 μ fd.
Input.....	3.20 μ fd.
Output.....	6.00 μ fd.

*With 1¹/₄" dia. shield (RMA Std. 308) connected to negative filament.

TYPICAL OPERATION

Filament Voltage DC.....	1.4	1.4 Volts
Filament Current.....	50	50 Ma.
Plate Voltage.....	45	90 Volts
Screen Voltage.....	45	45 Volts
Grid Voltage.....	0	0 Volt
Plate Current.....	0.55	0.6 Ma.
Screen Current.....	0.12	0.1 Ma.
Plate Resistance.....	900000	750000 Ohms
Mutual Conductance.....	550	575 μ mhos

For resistance coupled information refer to table in appendix.

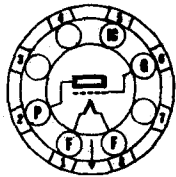

4AA-L-0

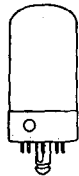

Sylvania Type 1LE3

MEDIUM-MU TRIODE

PHYSICAL SPECIFICATIONS

Base.....	Lock-In 8 Pin
Bulb.....	T-9
Maximum Overall Length.....	2 ⁵ / ₈ "
Maximum Seated Height.....	2 ¹ / ₄ "
Mounting Position.....	Any

RATINGS

Maximum Filament Voltage.....	1.6 Volts
Design Center for AC-DC Operation.....	1.3 Volts
Maximum Plate Voltage.....	110 Volts

Direct Interelectrode Capacitances:*

Grid to Plate.....	1.7 μ f.
Input.....	1.7 μ f.
Output.....	3.0 μ f.

*With 1³/₄" diameter shield (RMA Standard 308) connected to negative filament.

TYPICAL OPERATION

Filament Voltage DC.....	1.4	1.4 Volts
Filament Current.....	0.050	0.050 Ampere
Plate Voltage.....	90	90 Volts
Grid Voltage*.....	0	-3 Volts
Plate Current.....	4.5	1.4 Ma.
Plate Resistance.....	11200	19000 Ohms
Mutual Conductance.....	1300	760 μ mhos
Amplification Factor.....	14.5	14.5

*Negative Filament return to Pin No. 8.

For use in resistance coupled circuits, see appendix.



7AO-L-8



Sylvania Type 1LG5

SEMI-REMOTE CUT-OFF

RF PENTODE

PHYSICAL SPECIFICATIONS

Base.....	Lock-In 8 Pin
Bulb.....	T-9
Maximum Overall Length.....	2 ⁵ / ₈ "
Maximum Seated Height.....	2 ¹ / ₄ "
Mounting Position.....	Any

RATINGS

Maximum Filament Voltage Must Never Exceed.....	1.6 Volts
AC-DC Power Line Design Center.....	1.3 Volts
Maximum Plate Voltage.....	110 Volts
Maximum Screen Voltage.....	110 Volts

Direct Interelectrode Capacitances:*

Grid to Plate.....	.007 μ f. Max.
Input.....	3.2 μ f.
Output.....	7.0 μ f.

*With 1³/₄" diameter shield (RMA Std. 308) connected to negative filament.

TYPICAL OPERATION

Filament Voltage DC.....	1.4	1.4	1.4 Volts
Filament Current.....	50	50	50 Ma.
Plate Voltage.....	45	90	90 Volts
Screen Voltage.....	45	45	90 Volts
Control Grid Voltage.....	0	0	-1.5 Volts
Control Grid Resistor.....	2.0	2.0	2.0 Megohm
Suppressor Grid.....	Connected to Negative Filament at Socket		
Plate Current.....	1.5	1.7	3.7 Ma.
Screen Current.....	0.45	0.4	0.9 Ma.
Mutual Conductance.....	800	800	1150 μ mhos
Plate Resistance (Approx.).....	0.35	>1.0	0.5 Megohm
Control Grid Voltage for Gm=10 μ mhos (Approx.).....	-9.0	-10.0	-19 Volts

SYLVANIA RADIO TUBES

1LH4 Sylvania Type

DIODE HIGH-MU TRIODE

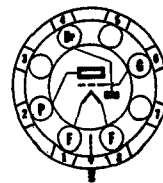
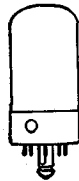

5AG-L-1

PHYSICAL SPECIFICATIONS

Base	Lock-In 8Pin
Bulb	T-9
Maximum Overall Length	2 15/16"
Maximum Seated Height	2 1/4"
Mounting Position	Any

RATINGS

Maximum Filament Voltage	1.6 Volts
Design Center for AC-DC Operation	1.3 Volts
Maximum Plate Voltage	110 Volts
Maximum Diode Drop at 0.5 Ma.	10 Volts

TYPICAL OPERATION

Filament Voltage DC	1.4 Volts
Filament Current	50 Ma.
Plate Voltage	90 Volts
Grid Voltage*	0 Volt
Plate Current	0.15 Ma.
Plate Resistance	240000 Ohms
Mutual Conductance	275 μ mhos
Amplification Factor	65

*A resistor of at least 1 megohm should be in the grid return so negative filament, pin No. 8.

Note; Diode plate location at negative end of filament.

For use in resistance coupled circuits, see appendix.

1LN5 Sylvania Type

SHARP CUT OFF RF PENTODE

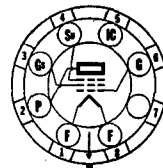
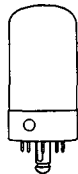

7AO-L-8

PHYSICAL SPECIFICATIONS

Base	Lock-In 8 Pin
Bulb	T-9
Maximum Overall Length	2 15/16"
Maximum Seated Height	2 1/4"
Mounting Position	Any

RATINGS

Maximum Filament Voltage	1.6 Volts
Design Center for AC-DC Operation	1.3 Volts
Maximum Plate Voltage	110 Volts
Maximum Screen Voltage	110 Volts

Direct Interelectrode Capacitances:*

Grid to Plate	0.007 μ f. Max.
Input	3.0 μ f.
Output	8.0 μ f.

*With 1 1/4" dia. (RMA Std. 308) shield connected to negative filament.

TYPICAL OPERATION

Filament Voltage DC	1.4 Volts
Filament Current	50 Ma.
Plate Voltage	90 Volts
Screen Voltage	90 Volts
Grid Voltage*	0 Volt
Plate Current	1.6 Ma.
Screen Current	0.35 Ma.
Plate Resistance	1.1 Megohms Approx.
Mutual Conductance	800 μ mhos
Mutual Conductance at -4.5 Volts (Approx.)	10 μ mhos

*Negative filament return, Pins No. 8 and 5.

For use in resistance coupled circuits, see appendix.



6Y-1-7



Sylvania Type 1LN5

SHARP CUT-OFF RF PENTODE

PHYSICAL SPECIFICATIONS

Base.....	Small Wafer 7-Pin Octal Metal Sleeve
Bulb.....	T-9
Cap.....	Miniature
Maximum Overall Length.....	3 3/8"
Maximum Seated Height.....	2 3/4"
Mounting Position.....	Any

Direct Interelectrode Capacitances:*

Grid to Plate.....	0.07 μ f. Max.
Input.....	3.4 μ f.
Output.....	10.0 μ f.

*With 1 5/16" diameter shield (RMA Std. 308) connected to negative filament.

TYPICAL OPERATION

Filament Voltage DC.....	1.4 Volts
Filament Current.....	50 Ma.
Plate Voltage.....	90 Volts
Screen Voltage.....	90 Volts
Grid Voltage*.....	0 Volt
Plate Current.....	1.2 Ma.
Screen Current.....	0.3 Ma.
Plate Resistance (Approx.).....	1.5 Megohms
Mutual Conductance.....	750 μ mhos
Mutual Conductance at -3.2 Volts (Approx.).....	50 μ mhos
Mutual Conductance at -4 Volts (Approx.).....	5 μ mhos

*Negative filament return, Pin No. 7.

For Resistance Coupled Amplifier Data refer to type 1LN5 in appendix.

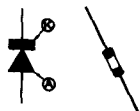

Sylvania Type 1N34

CRYSTAL DIODES

PHYSICAL SPECIFICATIONS

Style.....	See Outline
Connections.....	.025 Leads
Maximum Body Length.....	3/4"
Maximum Body Diameter.....	5/8"
Maximum Lead Length per Lead.....	1 1/8"
Mounting Position.....	Any
Temperature Range.....	-50 to +75° C.
Nominal Shunt Capacitance.....	1 μ f.
Cathode Terminal Indicated by Green Band on Body.	

RATINGS

Type	Peak Inverse Working Voltage	Peak Current Ma.	Transient Surge Current Ma.	Average Current Ma.	Minimum Forward Current At 1 Volt Ma.	Maximum Reverse Current μ a.
1N34 \emptyset	60	150	500	40	5.0	50 at -10 v; 800 at -50 v
1N35*	50	60	100	22.5	7.5	10 at -10 v
1N38 \emptyset	100	150	500	40	3.0	6 at -3 v; 625 at -100 v
1N39	200	150	500	40	3.0	200 at -100 v; 800 at -200 v
1N40 \blacklozenge	25	60	100	22.5	12.75 \dagger	50 at -10 v
1N41 \blacklozenge	25	60	100	22.5	12.75 \dagger	50 at -10 v
1N42 \blacklozenge	50	60	100	22.5	12.75 \dagger	6 at -3 v; 625 at -100 v
1N54 \emptyset	35	150	500	40	5.0	10 at -10 v
1N55 \emptyset	150	150	500	40	3.0	300 at -100 v; 800 at -150 v
1N56 \emptyset	40	200	1000	50	15.0	300 at -30 v
1N57	80	150	500	40	4.0	500 at -75 v
1N58 \emptyset	100	150	500	40	4.0	800 at -100 v
1N60	50	150	500	40	**	**
1N71 \textit{ff}	40	200	1000	50	15.0	300 at -30 v

*Type 1N35 consists of two Diode units mounted in a fibre assembly. The units are matched within 10% for resistance in the forward direction at 1 volt.

\dagger At 1.5 volts.

\blacklozenge Each unit contains 4 selected diodes matched within $\pm 2.5\%$ in the forward direction at 1.5 volts.

\emptyset Available in ceramic or glass cartridge. The letter A following the type number designates glass type.

**Units are tested in a circuit employing an input of 1.8 volts rms at 40 mc. 70% modulated at 400 cycles. Demodulated output across a 4700 ohm resistor shunted by a 5 μ f. capacitor is a minimum of 1.1 volts peak to peak.

\textit{ff} Consists of four matched low impedance germanium diodes each of which, with a voltage of one volt impressed in the forward direction, will pass a current within one ma. of the average current of the four. Ratings shown above are for each diode.

1N34 (Cont'd)

APPLICATION

Sylvania Germanium diodes are ruggedly built semi-conductors which may be used whenever a diode of their voltage and current rating is required. Their advantages are small size, no heater, low capacitance, no contact potential, and ruggedness.

A booklet describing their applications is available on request.

1P5^{GT} Sylvania Type

REMOTE CUT-OFF RF PENTODE

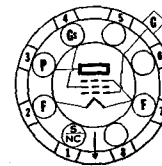

5Y-1-7

PHYSICAL SPECIFICATIONS

Base.....	Small Wafer 7-Pin Metal Sleeve
Bulb.....	T-9
Cap.....	Miniature
Maximum Overall Length.....	3 5/8"
Maximum Seated Height.....	2 3/4"
Mounting Position.....	Any
Direct Interelectrode Capacitances:*	
Grid to Plate.....	0.007 μ f. Max.
Input.....	2.2 μ f.
Output.....	10.0 μ f.
*With 1 1/16" diameter shield (RMA 308) connected to negative filament.	

TYPICAL OPERATION

Filament Voltage DC.....	1.4 Volts
Filament Current.....	50 Ma.
Plate Voltage.....	90 Volts
Screen Voltage.....	90 Volts
Grid Voltage.....	0 Volt
Plate Current.....	2.3 Ma.
Screen Current.....	0.7 Ma.
Plate Resistance (Approx.).....	0.8 Megohm
Mutual Conductance.....	750 μ mhos
Mutual Conductance at -12 Volts Bias.....	10 μ mhos
*Negative Filament return, Pin No. 7.	

1Q5^{GT} Sylvania Type

BEAM POWER AMPLIFIER

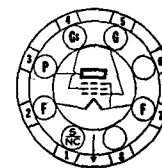

6AF-0-0

PHYSICAL SPECIFICATIONS

Base.....	Intermediate Octal 7-Pin
Bulb.....	T-9
Maximum Overall Length.....	3 5/8"
Maximum Seated Height.....	2 3/4"
Mounting Position.....	Any

RATINGS

Filament Voltage DC.....	1.4 Volts
Filament Current.....	100 Ma.
Maximum Plate Voltage.....	110 Volts
Maximum Screen Voltage.....	110 Volts
Maximum Cathode Current at Zero Signal.....	12 Ma.

TYPICAL OPERATION

Filament Voltage DC.....	1.4	1.4 Volts
Filament Current.....	100	100 Ma.
Plate Voltage.....	85	90 Volts
Screen Voltage.....	85	90 Volts
Grid Voltage.....	-5.0	-4.5 Volts
Peak A-F Signal Voltage.....	5.0	4.5 Volts
Plate Current (Zero Signal).....	7.0	9.5 Ma.
Screen Current (Zero Signal).....	0.8	1.6 Ma.
Mutual Conductance.....	1950	2200 μ mhos
Load Resistance.....	9000	8000 Ohms
Power Output.....	250	270 Mw.
Total Harmonic Distortion.....	5.5	6.0 Per Cent

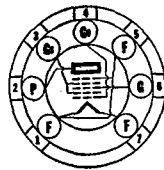

7AT-0-0

**Sylvania Type 1R5**

HEPTODE CONVERTER

PHYSICAL SPECIFICATIONS

Base.....	Miniature Button 7-Pin
Bulb.....	T-5 1/2
Maximum Overall Length.....	2 1/8"
Maximum Seated Height.....	1 1/8"
Mounting Position.....	Any

RATINGS

Maximum Filament Voltage.....	1.6 Volts
Desing Center for AC-DC Operation.....	1.3 Volts
Maximum Plate Voltage.....	90 Volts
Maximum Screen Voltage.....	67.5 Volts
Maximum Screen Supply.....	90 Volts
Maximum Cathode Current.....	5.5 Ma.

Direct Interelectrode Capacitances:*

Grid Go to Plate.....	0.10 μ fd.
Signal Input.....	7.0 μ fd.
Mixer Output.....	7.5 μ fd.
Oscillator Input.....	3.8 μ fd.
Grid (G) to Plate.....	0.4 μ fd. Max.
Grid (G) to Grid (Go).....	0.2 μ fd. Max.
Grid (Go) to Plate.....	0.1 μ fd. Max.

*Without shield.

TYPICAL OPERATION

Filament Voltage.....	1.4	1.4	1.4	1.4 Volts
Filament Current.....	0.050	0.050	0.050	0.050 Ampere
Plate Voltage.....	45	67.5	90	90 Volts
Screen Voltage.....	45	67.5	45	67.5 Volts
Grid Voltage.....	0	0	0	0 Volt
Oscillator-Grid Resistor (Rgo).....	0.1	0.1	0.1	0.1 Megohm
Plate Resistance (Approx.).....	0.6	0.5	0.8	0.6 Megohm
Plate Current.....	0.7	1.4	0.8	1.6 Ma.
Screen Current.....	1.9	3.2	1.9	3.2 Ma.
Oscillator-Grid Current.....	0.15	0.25	0.15	0.25 Ma.
Total Cathode Current.....	2.75	5.0	2.75	5.0 Ma.
Conversion Conductance.....	235	280	250	300 μ mhos
Grid Voltage (G) for Conversion Conductance of 5 μ mhos.....	-9	-14	-9	-14 Volts

APPLICATION

Sylvania Type 1R5 is a pentagrid converter of the miniature line especially designed for mixer-oscillator service in compact, light weight, portable equipment. The operating efficiency allows the tube to be used with extremely low B. Supply voltages. The internal construction of the tube is similar to that of Sylvania Type 6SA7GT, with the exception of the filament. Circuit applications for Type 6SA7GT may be used for Sylvania type 1R5.

1R5 (Cont.)

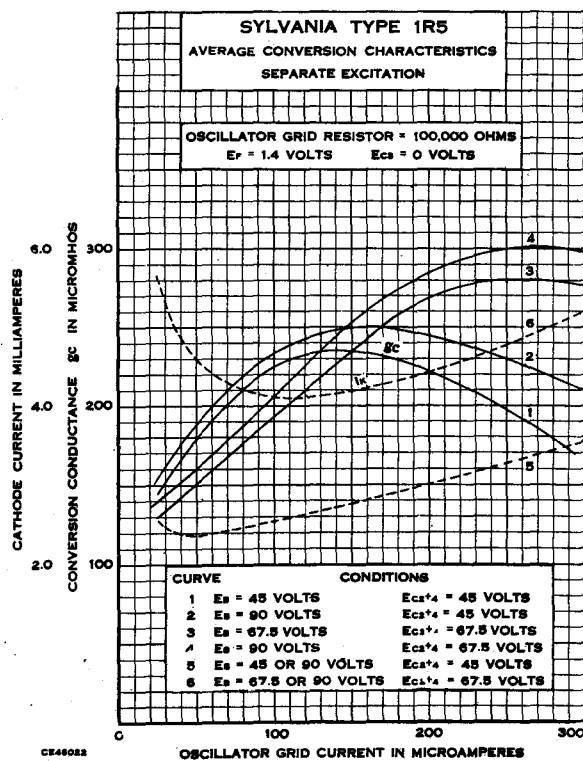
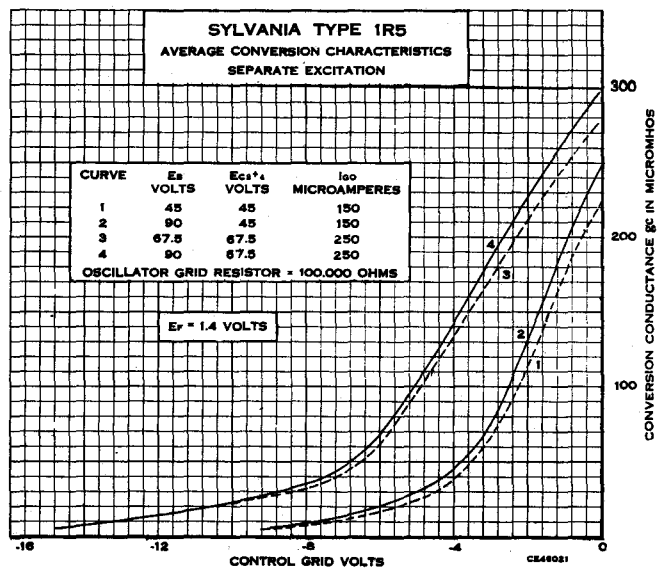



7AV-0-0



Sylvania Type 1S4

POWER AMPLIFIER PENTODE

PHYSICAL SPECIFICATIONS

Base.....	Miniature Button 7-Pin
Bulb.....	T6 1/4
Maximum Overall Length.....	2 1/4"
Maximum Seated Height.....	1 1/4"
Mounting Position.....	Any

RATINGS

Maximum Filament Voltage.....	1.6 Volts
Design Center for AC-DC Operation.....	1.8 Volts
Maximum Plate Voltage.....	90 Volts
Maximum Screen Voltage.....	67.5 Volts
Maximum Cathode Current Zero Signal.....	9.0 Ma.
Maximum Cathode Current Maximum Signal.....	11.0 Ma.

TYPICAL OPERATION

CLASS A AMPLIFIER

Filament Voltage DC.....	1.4	1.4	1.4 Volts
Filament Current.....	0.100	0.100	0.100 Ampere
Plate Voltage.....	45	67.5	90 Volts
Screen Voltage.....	45	67.5	67.5 Volts
Grid Voltage*.....	-4.5	-7	-7 Volts
Peak A-F Signal Voltage.....	4.5	7	7 Volts
Zero Signal Plate Current.....	3.8	7.2	7.4 Ma.
Zero Signal Screen Current.....	0.8	1.5	1.4 Ma.
Plate Resistance (Approx.).....	0.1	0.1	0.1 Megohm
Mutual Conductance.....	1250	1550	1575 μ mhos
Load Resistance.....	8000	5000	8000 ohms
Power Output.....	65	180	270 Milliwatts
Total Harmonic Distortion.....	12	10	12 Per Cent

*Negative Filament Return, Pin No. 1

APPLICATION

Sylvania Type 1S4 is a power amplifier pentode of the Miniature construction, especially designed for output service in compact, light weight, portable equipment. The high operating efficiency allows the tube to be used with extremely low B. Supply voltages.

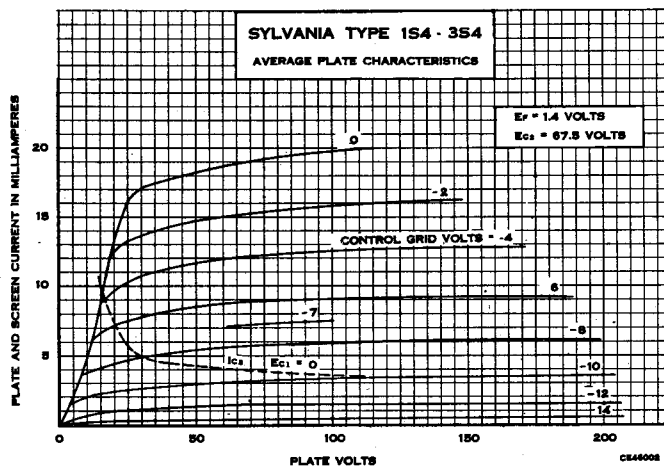

1S5 Sylvania Type

DIODE PENTODE AMPLIFIER

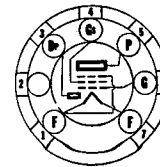

6AU-0-0

PHYSICAL SPECIFICATIONS

Base.....	Miniature Button 7-Pin
Bulb.....	T5 1/2
Maximum Overall Length.....	2 1/4"
Maximum Seated Height.....	1 1/8"
Mounting Position.....	Any

RATINGS

Maximum Filament Voltage.....	1.6 Volts
Design Center for AC-DC Operation.....	1.3 Volts
Maximum Plate Voltage.....	90 Volts
Maximum Screen Voltage.....	90 Volts
Maximum Signal Cathode Current.....	3.0 Ma.
Maximum Diode Current.....	0.25 Ma.

Direct Interelectrode Capacitances:*

Grid to Plate.....	0.2 μ f.
Input.....	2.2 μ f.
Output.....	2.4 μ f.

*With no external shielding.

TYPICAL OPERATION

Filament Voltage DC.....	1.4	1.4 Volts
Filament Current.....	50	50 Ma.
Plate Voltage.....	67.5	90 Volts
Screen Voltage.....	67.5	90 Volts
Grid Voltage.....	0	0 Volt
Plate Current.....	1.6	2.7 Ma.
Screen Current.....	0.4	0.5 Ma.
Plate Resistance (Approx.).....	0.6	0.5 Megohm
Mutual Conductance.....	625	720 μ mhos

Note: Diode plate located at negative end of filament.

APPLICATION

Sylvania Type 1S5 is a diode pentode of the miniature construction, especially designed for detector-audio service in compact, light weight, portable equipment. The high operating efficiency allows the tube to be used with extremely low B supply voltages. The internal construction of Type 1S5 is similar to that of Sylvania Type 1LD5.

For use in resistance coupled circuits, see appendix.

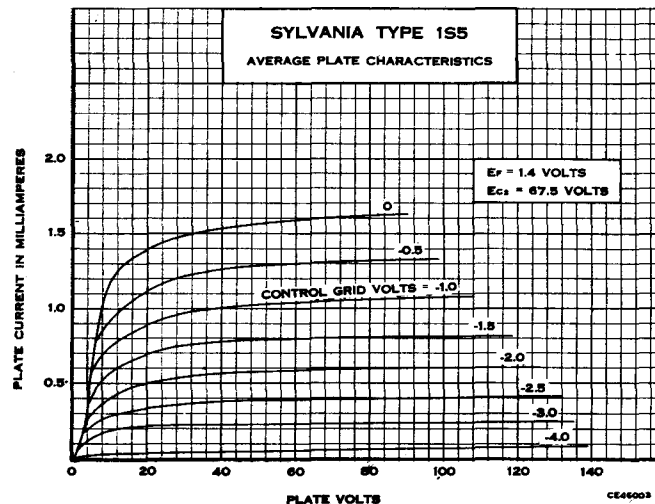

SYLVANIA RADIO TUBES

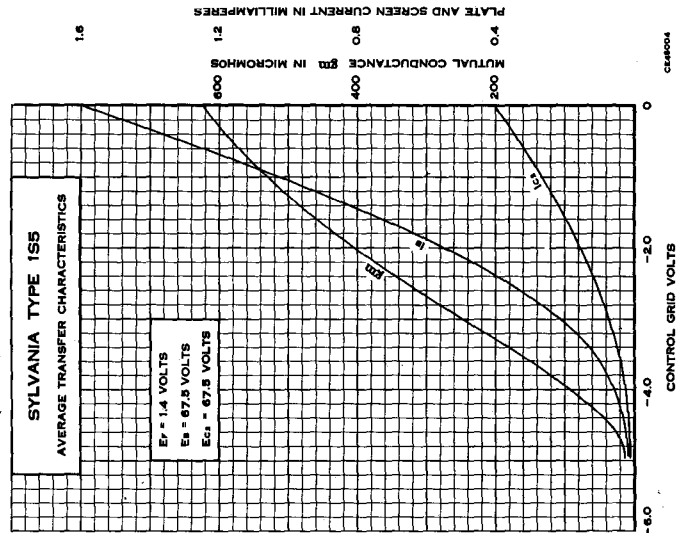

8DA-0-0

**Sylvania Type 1S6**

DIODE PENTODE

PHYSICAL SPECIFICATIONS

Base.....	Flexible Leads
Bulb.....	T-3
Maximum Bulb Length.....	1 1/2"
Minimum Lead Length.....	1 1/4"
Mounting Position.....	Any

For additional data and curves, reference should be made to Type 1T6 which has the same operating conditions but differs in lead length.



6AR-0-1 & 5

**Sylvania Type 1T4**

REMOTE CUT-OFF RF PENTODE

PHYSICAL SPECIFICATIONS

Base.....	Miniature Button 7-Pin
Bulb.....	T5 1/2
Maximum Overall Length.....	2 1/2"
Maximum Seated Height.....	1 7/8"
Mounting Position.....	Any

RATINGS

Maximum Filament Voltage DC.....	1.6 Volts
Filament Voltage DC (design center of AC-DC Power Line Operation).....	1.3 Volts
Maximum Plate Voltage.....	90 Volts
Maximum Screen Voltage.....	90 Volts
Maximum Total Cathode Current.....	5.5 Ma.
Minimum Grid Bias Voltage.....	0 Volt

Direct Interelectrode Capacitances:*

Grid to Plate.....	0.01 μ f. Max.
Grid to all Electrodes Except Plate.....	3.6 μ f.
Plate to All Electrodes Except Grid G.....	7.5 μ f.

*With close-fitting tube shield connected to negative filament.

1T4 (Cont'd)

TYPICAL OPERATION

Filament Voltage DC.....	1.4	1.4	1.4	1.4 Volts
Filament Current.....	50	50	50	50 Ma.
Plate Voltage.....	45	67.5	90	90 Volts
Screen Voltage.....	45	67.5	45	67.5 Volts
Grid Voltage.....	0	0	0	0 Volt
Plate Current.....	1.7	3.4	1.8	3.5 Ma.
Screen Current.....	0.7	1.5	0.65	1.4 Ma.
Plate Resistance (Approx.).....	0.35	0.25	0.8	0.5 Megohm
Mutual Conductance.....	700	875	750	900 μ mhos
Grid Voltage for 10 μ mhos.....	-10	-16	-10	-16 Volts

APPLICATION

Sylvania Type 1T4 is a rf-if remote cut-off pentode of the miniature style of construction. It is especially designed for radio frequency amplifier service in compact, light weight, portable equipment. The high operating efficiency allows the tube to be used with extremely low B supply voltages. The construction incorporates internal shielding which is connected to minus filament, and eliminates the need for an external bulb shield. A shielded socket should be employed to obtain the minimum Grid-plate capacity.

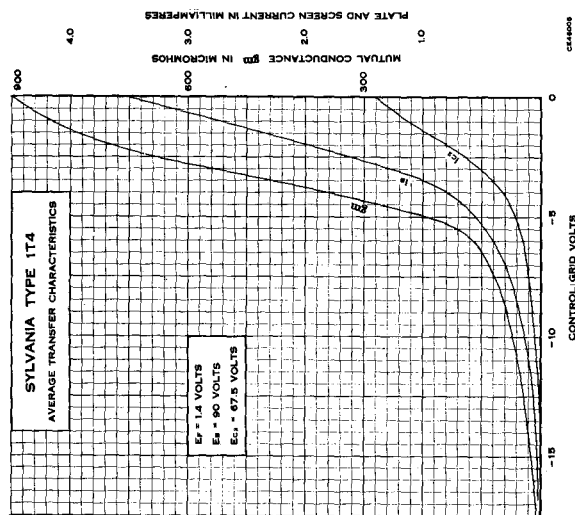
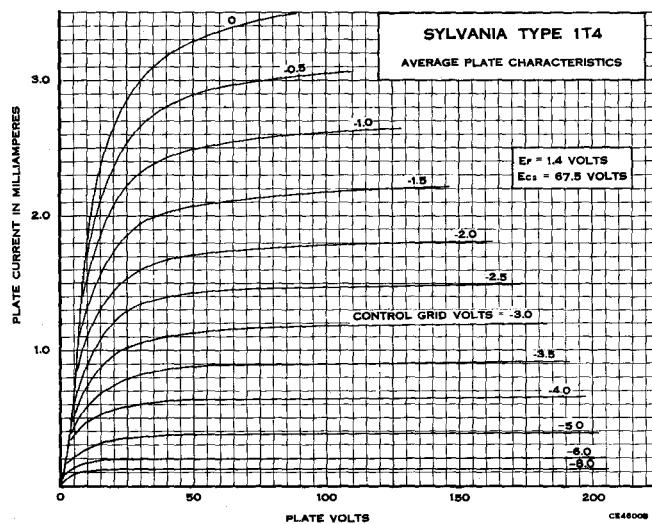



6X-0-0



Sylvania Type 1T6

PENTODE POWER AMPLIFIER

PHYSICAL SPECIFICATIONS

Base.....	Intermediate Octal 7 Pin
Bulb.....	T-9
Maximum Overall Length.....	3 ⁵ / ₁₆ "
Maximum Seated Height.....	2 ³ / ₄ "
Mounting Position.....	Any

RATINGS

Maximum Filament Voltage.....	1.6 Volts
Dry Battery Operation—Must Never Exceed.....	1.3 Volts
AC-DC Power Line Operation—Design Center.....	110 Volts
Maximum Plate Voltage.....	110 Volts
Maximum Screen Voltage.....	110 Volts
Maximum Cathode Current (Zero Signal).....	7.3 Ma.

TYPICAL OPERATION

	Self Bias	Fixed Bias
Filament Voltage.....	1.4	1.4 Volts
Filament Current.....	0.05	0.05 Ampere
Plate Voltage.....	84.0	90 Volts
Screen Voltage.....	84.0	90 Volts
Control Grid Voltage.....	-6.0	-6.0 Volts
Plate Resistance (Approximate).....	0.25	0.25 Megohms
Mutual Conductance.....	1050	1150 μ mhos
Plate Current (Zero Signal).....	5.4	6.5 Ma.
Plate Current (Maximum Signal).....	5.5	6.5 Ma.
Screen Current (Zero Signal).....	0.6	0.8 Ma.
Screen Current (Maximum Signal).....	1.5	1.5 Ma.
Load Resistance.....	14000	14000 Ohms
Total Harmonic Distortion.....	7.5	7.5 Per Cent
Power Output.....	145	170 Milliwatts

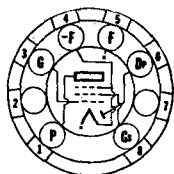

8DA-0-0



Sylvania Type 1T6

DIODE PENTODE

PHYSICAL SPECIFICATIONS

Base.....	Subminiature Button 8 Pin
Bulb.....	T-3
Maximum Overall Length.....	1 ³ / ₄ "
Maximum Seated Height.....	1 ¹ / ₂ "
Mounting Position.....	Any

RATINGS

Filament Voltage.....	1.25 Volts
Maximum Plate Voltage.....	67.5 Volts
Maximum Screen Voltage.....	67.5 Volts
Maximum Cathode Current (Pentode Section).....	2.0 Ma.
Maximum Diode Current for continuous operation.....	0.25 Ma.

TYPICAL OPERATION

CLASS A OPERATION

Filament Voltage DC.....	1.25	1.25	1.25 Volts
Filament Current.....	40	40	40 Ma.
Plate Voltage.....	30	45	67.5 Volts
Screen Voltage.....	30	45	67.5 Volts
Grid Voltage.....	0	0	0 Volts
Plate Current.....	0.33	0.75	1.6 Ma.
Screen Current.....	0.10	0.21	0.4 Ma.
Plate Resistance (Approx.).....	0.5	0.5	0.4 Megohm
Mutual Conductance.....	330	475	600 μ mhos
Average Diode Current with 10 Volts DC ..	1.5	1.5	1.5 Ma.

1T6 (Cont'd)

AS A RESISTANCE COUPLED AMPLIFIER

Plate Voltage.....	30	45	67.5 Volts
Screen Voltage.....	30	45	67.5 Volts
Voltage Gain (Approx.).....	30 (1)	50 (2)	60 (2)
(1) With $R_{c2}=2.2$ megohms	$R_b=1.0$ megohms	$R_{c1}=4.7$ megohms	
(2) With $R_{c2}=3.9$ megohms	$R_b=1.0$ megohms	$R_{c1}=4.7$ megohms	

APPLICATION

Sylvania Type 1T6 is a diode audio pentode tube suitable for use in very small radio sets or amplifiers. The other types required for a normal set complement and designed for such usage are Types 1E8 (Converter), 1AD5 (RF Pentode Amplifier) and 1AC5 (Output Pentode).

This type corresponds in service and circuit design to Types 1LD5 and 1S5 but is rated for use at lower voltages. The gains are comparable considering the reduced size and voltages.

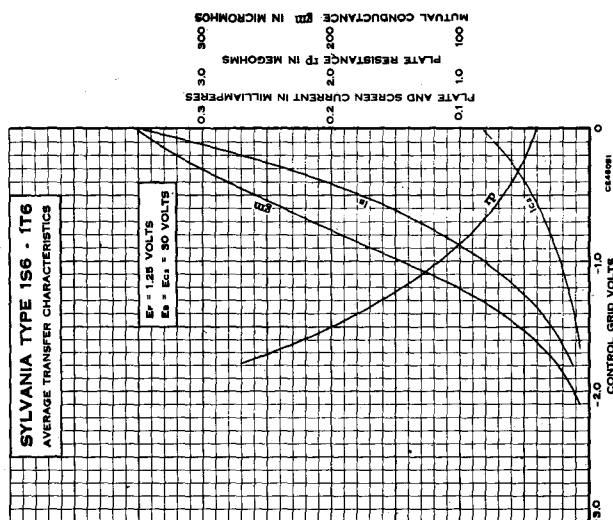
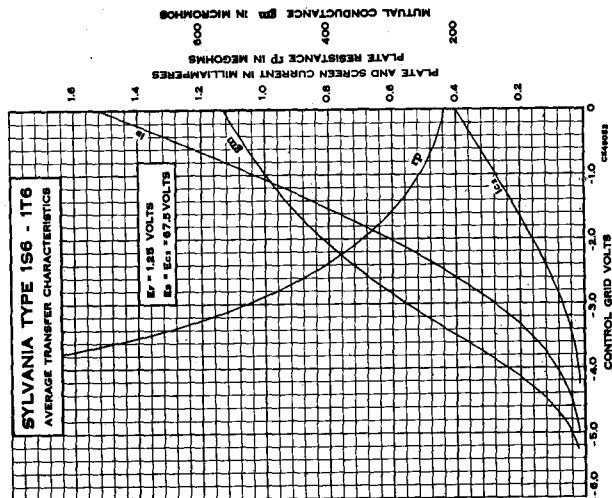

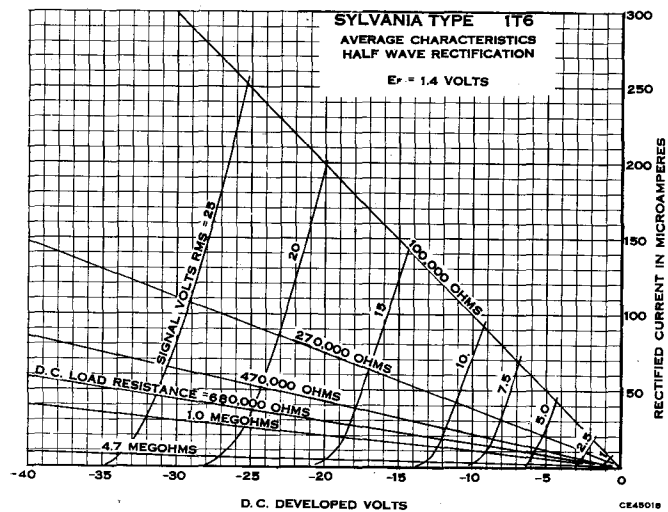
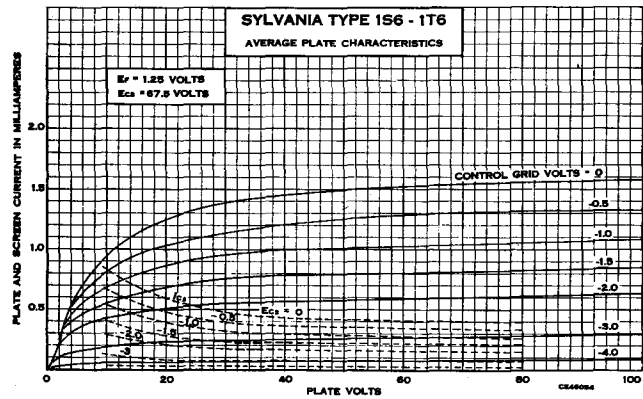
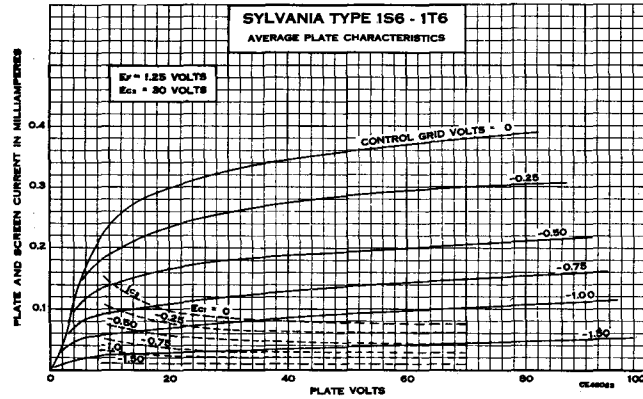

1U4 Sylvania Type

SHARP CUT-OFF RF PENTODE

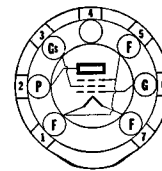
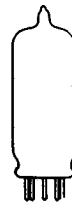

6AR-0-1 & 5

PHYSICAL SPECIFICATIONS

Base.....	Miniature 7-Pin
Bulb.....	T-5 $\frac{1}{2}$
Maximum Overall Length.....	2 $\frac{1}{8}$ "
Maximum Seated Height.....	1 $\frac{3}{8}$ "
Mounting Position.....	Any

RATINGS

Maximum Filament Voltage.....	1.6 Volts
Design Center for AC-DC Operation.....	1.3 Volts
Maximum Plate Voltage.....	110 Volts
Maximum Screen Voltage.....	110 Volts
Maximum Control Grid Voltage.....	-30 Volts
Minimum Control Grid Voltage.....	0 Volts
Maximum Total Cathode Current.....	6.5 Ma.

Direct Interelectrode Capacitances:*

Grid to Plate.....	.008 μ f. Max.
Input.....	3.6 μ f.
Output.....	7.5 μ f.

*With tight fitting external shield.

TYPICAL OPERATION

Filament Voltage DC.....	1.4 Volts
Filament Current.....	50 Ma.
Plate Voltage.....	90 Volts
Screen Voltage.....	90 Volts
Control Grid Voltage.....	0 Volts
Plate Resistance (Approx.).....	1.5 Megohms
Mutual Conductance.....	900 umhos
Plate Current.....	1.6 Ma.
Screen Current.....	0.45 Ma.
Grid Bias Voltage for Mutual Conductance of 10 umhos.....	-4.5 Volts

APPLICATION

Sylvania Type 1U4 is a sharp cut-off RF pentode very similar in application and characteristics to Type 1LN5. Data required for its use in resistance coupled amplifier circuits are shown in appendix.

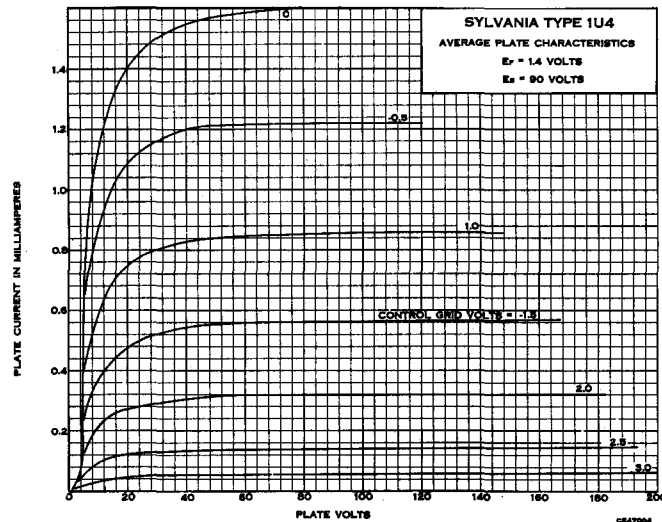

SYLVANIA RADIO TUBES

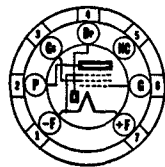
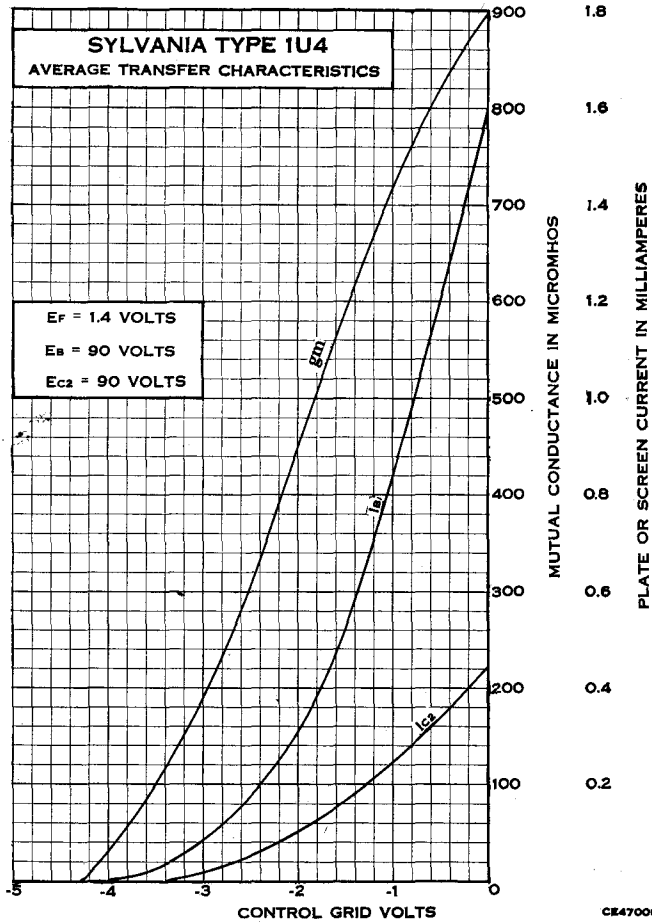

6BW-0-0

**Sylvania Type 1U5**

DIODE PENTODE AMPLIFIER

PHYSICAL SPECIFICATIONS

Base.....	Miniature Button 7 Pin
Bulb.....	T5 1/2"
Maximum Overall Length.....	2 1/4"
Maximum Seated Height.....	1 1/4"

Note: With the exception of the base diagram given above, the characteristics of type 1U5 are identical, except for Capacitances, with those given for type 185 including curves, and Resistance Coupled Amplifier data given in appendix.

1V2 Sylvania Type

HALF WAVE VACUUM RECTIFIER

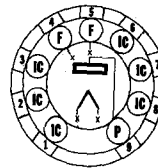

9U-0-0

PHYSICAL SPECIFICATIONS

Base.....	Miniature-Button 9-pin
Bulb.....	T6 $\frac{1}{2}$
Maximum Overall Length.....	2 $\frac{3}{16}$ "
Maximum Seated Height.....	1 $\frac{15}{16}$ "
Mounting Position.....	Any

RATINGS

Heater Voltage (AC).....	0.625 Volts
Heater Current.....	0.3 Amperes
Peak Inverse Plate Voltage (Max.).....	7,500 Volts
Peak Plate Current (Max.).....	10 Ma.
Average Plate Current (Max.).....	0.5 Ma.
Direct interelectrode Capacitance (Approx.) with no external shield Plate to Filament.....	0.8 μ f.

APPLICATION

Sylvania Type 1V2 is a half-wave rectifier designed especially for use in television circuits using fly-back or high frequency oscillator supplies.

1V5 Sylvania Type

OUTPUT PENTODE

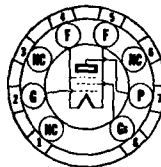

8CP-0-0

PHYSICAL SPECIFICATIONS

Base.....	Flexible Leads
Bulb.....	T-3
Maximum Bulb Length.....	1 $\frac{1}{4}$ "
Minimum Lead Length.....	1 $\frac{1}{4}$ "
Mounting Position.....	Any

For additional data and curves, reference should be made to Type 1AC5 which has the same operating conditions but differs in lead length.

1W4 Sylvania Type

POWER AMPLIFIER PENTODE

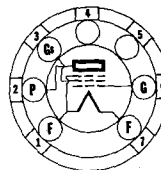

5BZ-0-0

PHYSICAL SPECIFICATIONS

Base.....	Miniature Button 7-pin
Bulb.....	T5 $\frac{1}{2}$
Maximum Overall Length.....	2 $\frac{1}{4}$ "
Maximum Seated Height.....	1 $\frac{1}{8}$ "
Mounting Position.....	Any

SYLVANIA RADIO TUBES

RATINGS

Filament Voltage.....	1.4 Volts
Maximum Plate Voltage.....	110 Volts
Maximum Screen Grid Voltage.....	110 Volts
Maximum Cathode Current.....	6.0 Ma.

TYPICAL OPERATION

Filament Voltage DC.....	1.4	1.4	1.4	1.4 Volts
Filament Current.....	50	50	50	50 Ma.
Plate Voltage.....	45	62.5	67.5	90 Volts
Screen Voltage.....	45	62.5	67.5	90 Volts
Grid Voltage.....	-4.5	-5.0	-6.0	-9.0 Volts
Plate Current.....	1.6	3.8	3.8	5.0 Ma.
Screen Current.....	0.3	0.8	0.8	1.0 Ma.
Plate Resistance (approx.).....	0.4	0.3	0.3	0.25 Megohms
Mutual Conductance.....	650	875	875	925 μ hos
Load Resistance.....	20,000	16,000	16,000	12,000 Ohms
Power Output.....	35	90	100	200 Milliwatts
Total Harmonic Distortion.....	10	10	10	10 %

APPLICATION

Sylvania Type 1W4 is a miniature filament type power output tube for use in low drain battery operated receivers. Electrical characteristics are identical with those for Type 1LB4, including design for maximum power output with low B supply voltage.



SCP-0-0



Sylvania Type 1W5

SHARP CUT-OFF RF PENTODE

PHYSICAL SPECIFICATIONS

Base.....	Flexible Leads
Bulb.....	T-3
Maximum Bulb Length.....	1 1/2"
Minimum Lead Length.....	1 1/2"
Mounting Position.....	Any

For additional data and curves, reference should be made to Type 1AD5 which has the same operating conditions but differs in lead length.

1X2 Sylvania Type

HIGH VOLTAGE HALF-WAVE RECTIFIER

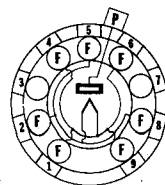
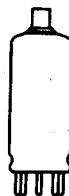

9Y-0-1, 4, 6 & 9

PHYSICAL SPECIFICATIONS

Base.....	Miniature Button 9-Pin
Bulb.....	T8 $\frac{1}{2}$
Cap.....	Skirted Miniature
Maximum Overall Length.....	2 $\frac{1}{4}$ "
Mounting Position.....	Any

RATINGS AND OPERATION

Filament Voltage.....	1.25 Volts
Filament Current.....	200 Ma.
Peak Inverse Plate Voltage (Max.).....	15,000 Volts
Peak Plate Current (Max.).....	10 Ma.
DC Output Current (Max.).....	1 Ma.
Frequency of Supply Voltage (Max.).....	300 kc.

APPLICATION

Sylvania Type 1X2 is a high voltage, half-wave rectifier. It is designed for use in television circuits using either rf or fly-back type of power supply, as well as for use at power line frequency. See type 1B3GT for suggestions on reducing corona loss etc.

2X2A Sylvania Type

HIGH VOLTAGE HALF-WAVE
RECTIFIER

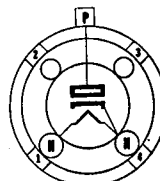

4AB-0-0

PHYSICAL SPECIFICATIONS

Base.....	Small 4 Pin
Bulb.....	ST12
Cap.....	Small Metal
Maximum Overall Length.....	4 $\frac{1}{4}$ "
Maximum Seated Height.....	3 $\frac{1}{2}$ "
Mounting Position.....	Any

RATINGS AND OPERATION

Heater Voltage.....	2.5 Volts
Heater Current.....	1.75 Amperes
Maximum RMS Plate Voltage.....	4500 Volts
Peak Inverse Plate Voltage.....	12,500 Volts
Peak Plate Current.....	100 Ma.
Minimum Effective Plate Supply Impedance.....	0 Ohms
DC Output Current (Maximum).....	7.5 Ma.

APPLICATION

Sylvania Type 2X2/879 is a high voltage, high vacuum half wave rectifier. It is designed for use in applications requiring high DC voltages at low current loads such as for anode supplies for cathode ray tubes. Filter requirements for this type of service are easily met since a simple resistive, capacitive filter is usually adequate. Care should be taken to provide adequate insulation as in any high voltage installation.



7BB-0-0



Sylvania Type 3A4

POWER AMPLIFIER PENTODE

PHYSICAL SPECIFICATIONS

Base.....	Miniature Button 7 Pin
Bulb.....	T5 1/2
Maximum Overall Length.....	2 1/2"
Maximum Seated Height.....	1 1/2"
Mounting Position.....	Any

TYPICAL OPERATION

Filament Voltage.....	1.4 or 2.8* Volts
Filament Current.....	200 or 100 Ma.
Plate Voltage.....	135 150 Volts
Screen Voltage.....	90 90 Volts
Grid Voltage.....	-7.5 -8.4 Volts
Plate Current.....	14.8 13.3 Ma.
Screen Current.....	2.6 2.2 Ma.
Mutual Conductance.....	1900 1900 μ mhos
Load Resistance.....	8000 8000 Ohms
Power Output Maximum Signal.....	600 700 Mw.

*For operation at 2.8 volts (filaments in series) a shunting resistor must be connected between pins 1 and 5 to make the voltage at this point equal to that across pins 5 and 7.

APPLICATION

Sylvania Type 3A4 is a miniature power amplifier pentode. It is similar to types 3Q4 and 3S4, but has higher plate voltage and current ratings with greater power output.

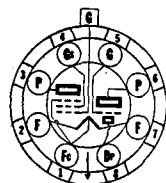

8AS-0-1



Sylvania Type 3A8GT

DIODE TRIODE
RF PENTODE

PHYSICAL SPECIFICATIONS

Base.....	Intermediate Octal 8-Pin
Bulb.....	T-9
Cap.....	Miniature
Maximum Overall Length.....	3 1/2"
Maximum Seated Height.....	2 1/4"
Mounting Position.....	Any

RATINGS

	Series	Parallel
Maximum Filament Voltage		
Dry Battery Operation Must Never Exceed.....	3.2	1.6 Volts
AC-DC Power Line Operation Design Center.....	2.6	1.3 Volts
Maximum Plate Voltage		
Pentode.....	110	110 Volts
Triode.....	110	110 Volts
Maximum Screen Voltage.....	110	110 Volts
Minimum Diode Current with 10 Volts DC applied*	0.5	0.5 Ma.
Maximum Diode Current Continuous Operation.....	0.25	0.25 Ma.
	Triode	Pentode
Direct Interelectrode Capacitances:†		
Grid to Plate.....	2.0	0.012 μ l. Max.
Input.....	2.6	3.0 μ l.
Output.....	4.2	10.0 μ l.

*The diode triode filament is connected to pins 1 and 7. The diode is located at the negative end of the filament.

†With 1 1/16" diameter shield (RMA Std. 308) Connected to Negative Filament.

3A8^{GT} (Cont'd)

TYPICAL OPERATION

	Series	Parallel
Filament Voltage DC	2.8	1.4 Volts
Filament Current	50	50 Ma.
	Triode	Pentode
Plate Voltage	90	90 Volts
Screen Voltage	0	90 Volts
Grid Voltage**	0	0 Volt
Plate Resistance (Approximate)	0.2	0.8 Megohm
Mutual Conductance	325	750 μ mhos
Plate Current	0.2	1.5 Ma.
Screen Current		0.5 Ma.

**Grid bias voltage is measured from the negative filament terminal of each unit. With Series filament, pin number 7 is the negative for the diode triode section and pin number 1 for the pentode section. With parallel filaments pin number 7 becomes negative for both.

Data for use in Resistance Coupled Amplifiers may be obtained by referring to types 1LN5 and 1LH4 in appendix.

3D6 Sylvania Type

BEAM POWER AMPLIFIER

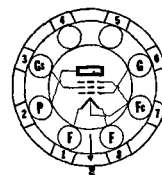
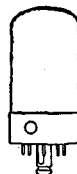

6BB-L-0

PHYSICAL SPECIFICATIONS

Base	Lock-In 8-Pin
Bulb	T-9
Maximum Overall Length	2 ³⁵ / ₆₄ "
Maximum Seated Height	2 ¹ / ₄ "
Mounting Position	Any

RATINGS

	Series	Parallel
Maximum Filament Voltage DC	3.5*	1.75* Volts
Minimum Filament Voltage DC	2.8	1.40 Volts
Filament Current	0.110	0.220 Ampere
Maximum Plate Voltage	180	180 Volts
Maximum Screen Voltage	135	135 Volts
Maximum Cathode Current [‡]	30	30 Ma.
Maximum Plate Dissipation	4.5	4.5 Watts
Maximum Screen Dissipation	0.9	0.9 Watt

*For parallel operation, connect pins No. 1 and No. 8 to positive voltage supply, and pin No. 7 to negative voltage supply. For series operation, connect pin No. 1 to positive and pin No. 8 to negative.

‡When series operated, a shunting resistor should be connected across the section of filament between pins No. 7 and No. 8 of sufficient value to by-pass any cathode current in excess of the maximum per section. If other tubes in a series filament arrangement contribute to the filament current of Type 3D6, an additional shunting resistor may be required between pins No. 1 and No. 8.

Direct Interelectrode Capacitances:	Note 1	Note 2
Control Grid to Plate	0.30	0.30 μ mf.
Input	7.5	7.5 μ mf.
Output	5.5	6.5 μ mf.

Note 1. With no external shield (Pin No. 5 connected to filament center tap).
 Note 2. With 1¹/₄" diameter shield (RMA Std. M8-308) connected to negative filament (Pin No. 5 connected to filament center tap).

TYPICAL OPERATION A-F POWER AMPLIFIER CLASS A₁

Filament Voltage	1.4	1.4	1.4 Volts
Filament Current	0.220	0.220	0.220 Ampere
Plate Voltage	90	135	150 Volts
Screen Voltage	90	90	90 Volts
Grid Voltage	-4.5	-4.5	-4.5 Volts
Peak A-F Signal Voltage	4.5	4.5	4.5 Volts
Plate Current Zero Signal	9.5	9.8	9.9 Ma.
Plate Current Maximum Signal	8.5	9.8	10.2 Ma.
Screen Current Zero Signal	1.6	1.2	1.0 Ma.
Screen Current Maximum Signal	3.2	2.0	1.8 Ma.
Mutual Conductance	2400	2400	2400 μ mhos
Load Resistance	8000	12000	14000 Ohms
Total Distortion	5	5	5 Per Cent
Power Output	270	500	600 Mw.

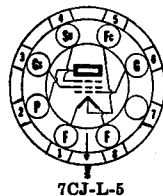

7CJ-L-5

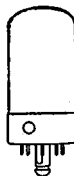

Sylvania Type 3E6

SHARP CUT-OFF RF PENTODE

PHYSICAL SPECIFICATIONS

Base.....	Lock-In 8-Pin
Bulb.....	T-9
Maximum Overall Length.....	2 ³³ / ₆₄ "
Maximum Seated Height.....	2 ¹ / ₄ "
Mounting Position.....	Any

RATINGS

	Parallel	Series
Maximum Filament Voltage.....	1.6	3.2 Volts
Design Center for AC, DC Operation.....	1.3	2.6 Volts
Maximum Plate Voltage.....	110	110 Volts
Maximum Screen Voltage.....	110	110 Volts
Maximum Cathode Current.....	12.0	6.0* Ma.

For parallel filament operation, connect pins 1 and 8 to positive supply and pin 5 to negative supply. For series operation, pin No. 1 is positive and pin No. 8 is negative.

*For each 1.4 volt section. A shunting resistor across the negative filament section is necessary to limit current to value given.

Direct Interelectrode Capacitances:**

Grid to Plate.....	0.007 μ f. Max.
Input.....	5.5 μ f.
Output.....	8.0 μ f.

**With 1¹/₁₆" dia. shield (RMA Std. 308) connected to negative filament.

TYPICAL OPERATION

	Parallel	Series
Filament Voltage DC.....	1.4	2.8 Volts
Filament Current.....	100	50 Ma.
Plate Voltage.....	90	90 Volts
Screen Voltage.....	90	90 Volts
Grid Voltage.....	0	0 Volt
Grid Resistor.....	2.0	2.0 Megohms
Plate Current.....	4.2	2.9 Ma.
Screen Current.....	1.7	1.2 Ma.
Mutual Conductance.....	2000	1700 μ mhos
Plate Resistance.....	0.25	0.325 Megohm
Grid Voltage for $I_b=10 \mu$ a.....	-5.5	-4.0 Volts



6BB-L-0

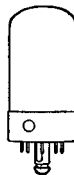

Sylvania Type 3LF4

BEAM POWER AMPLIFIER

PHYSICAL SPECIFICATIONS

Base.....	Lock-In 8-Pin
Bulb.....	T-9
Maximum Overall Length.....	2 ³³ / ₆₄ "
Maximum Seated Height.....	2 ¹ / ₄ "
Mounting Position.....	Any

RATINGS

	Series*	Parallel†
Maximum Filament Voltage.....	3.2	1.6 Volts
Dry Battery Operation must never Exceed.....	2.6	1.3 Volts
AC-DC Power Line Operation—Design Center.....	110	110 Volts
Maximum Plate Voltage.....	110	110 Volts
Maximum Screen Voltage.....	110	110 Volts
Maximum Cathode Current.....	6*	12 Ma.

3LF4 (Cont'd)

TYPICAL OPERATION CLASS A AMPLIFIER

	Series*			Parallel†	
Filament Voltage.....	2.8	2.8	1.4	1.4	1.4 Volts
Filament Current.....	0.050	0.050	0.100	0.100	0.100 Ampere
Plate Voltage.....	90	110	85	90	110 Volts
Screen Voltage.....	90	110	85	90	110 Volts
Grid Voltage.....	-4.5	-6.6	-5.0	-4.5	-6.6 Volts
Peak A-F Signal Voltage.....	4.5	5.1 δ	5.0	4.5	5.4 δ Volts
Plate Current.....	8.0	8.5	7.0	9.5	10 Ma.
Screen Current.....	1.0	1.1	0.8	1.3	1.4 Ma.
Plate Resistance (App.).....	80000	110000	70000	90000	100000 Ohms
Mutual Conductance.....	2000	2000	1950	2200	2200 μ mhos
Load Resistance.....	8000	8000	9000	8000	8000 Ohms
Total Harmonic Distortion.....	8.5	8.5	5.5	6.0	6.0 Per Cent
Power Output.....	230	330	250	270	400 Mw.

*A resistor of 270 ohms must be used in parallel with the negative section of the filament (Pins 7 and 8) in order to insure that the value of 6.0 Ma. total cathode current for each 1.4 volt section of the filament is not exceeded. When other tubes in series filament circuits contribute to the filament current of the 3LF4, an additional shunt resistor between pins 1 and 8 will be required.

†For parallel operation, connect pins 1 and 8 to the positive of the voltage supply and pin 7 to the negative.

δ Use of a peak signal voltage equal to the bias voltage gives power output of 400 Mw. at 10% distortion and 500 Mw. at 10% distortion for the parallel connection.

3Q4 Sylvania Type

BEAM POWER AMPLIFIER



7BA-0-0

PHYSICAL SPECIFICATIONS

Base.....	Miniature Button 7 Pin
Bulb.....	T-5 1/2
Maximum Overall Length.....	2 1/8"
Maximum Seated Height.....	1 1/8"
Mounting Position.....	Any

RATINGS

	Parallel	Series
Filament Voltage		
Dry Battery Operation Must Never Exceed.....	1.6	3.2 Volts
AC-DC Power Line Operation Design Center.....	1.3	2.6 Volts
Maximum Plate Voltage.....	90	90 Volts
Maximum Screen Voltage.....	90	90 Volts
Maximum Cathode Current (Zero Signal)*.....	12	6 Ma.

*When series filament connections are used a shunting resistor should be used across the negative filament section (pins 1 and 5) to limit cathode current to the value specified. If other tubes in a series filament string contribute to the filament current of the 3Q4, another resistor should be connected between pins 1 and 7 so chosen to carry any excess current over ratings.

TYPICAL OPERATION CLASS A₁ AMPLIFIER

	Parallel Filament		Series Filament
Filament Voltage DC.....	1.4	1.4	2.8 Volts
Filament Current.....	100	100	50 Ma.
Plate Voltage.....	85	90	90 Volts
Screen Voltage.....	85	90	90 Volts
Grid Voltage.....	-5.0	-4.5	-4.5 Volts
Peak Signal Voltage.....	5.0	4.5	4.5 Volts
Zero Signal Plate Current.....	6.9	9.5	7.7 Ma.
Zero Signal Screen Current.....	1.5	2.1	1.7 Ma.
Plate Resistance (Approximate).....	0.12	0.10	0.12 Megohm
Mutual Conductance.....	1975	2150	2000 μ mhos
Load Resistance.....	10000	10000	10000 Ohms
Total Harmonic Distortion.....	10	7	7 PerCent
Maximum Signal Power Output.....	0.25	0.27	0.24 Watt



7AP-0-0



Sylvania Type 3Q5

BEAM POWER AMPLIFIER

PHYSICAL SPECIFICATIONS

Base.....	Intermediate Octal 7 Pin
Bulb.....	T-9
Maximum Overall Length.....	3 $\frac{5}{16}$ "
Maximum Seated Height.....	2 $\frac{3}{4}$ "
Mounting Position.....	Any

RATINGS

	Series	Parallel
Maximum Filament Voltage.....	3.2	1.6 Volts
Dry Battery Operation Must Never Exceed.....	2.6	1.3 Volts
AC-DC Power Line Operation Design Center.....	2.6	1.3 Volts

TYPICAL OPERATION

	Series Filament	Parallel Filament
Filament Voltage DC.....	2.8	1.4 Volts
Filament Current.....	50	100 Ma.

For other rating and operating data refer to Sylvania Lock-In type 3LF4.

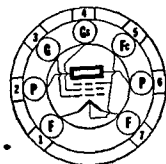

7BA-0-0



Sylvania Type 3S4

PENTODE POWER AMPLIFIER

PHYSICAL SPECIFICATIONS

Base.....	Miniature Button 7-Pin
Bulb.....	T5 $\frac{1}{2}$
Maximum Overall Length.....	2 $\frac{1}{8}$ "
Maximum Seated Height.....	1 $\frac{7}{8}$ "
Mounting Position.....	Any

RATINGS

	Parallel†	Series
Maximum Filament Voltage.....	1.6	3.2 Volts
Design Center for AC-DC Operation.....	1.3	2.6 Volts
Maximum Plate Voltage.....	90	90 Volts
Maximum Screen Voltage.....	67.5	67.5 Volts
Maximum Cathode Current.....	12.0	6.0* Ma.

†For parallel filament operation, tie pins 1 and 7. Negative end of filament connected to pin No. 5.

*A shunting resistor across negative filament section, pins 1 and 5, is necessary to limit cathode current to value given.

TYPICAL OPERATION

AMPLIFIER CLASS A₁

	Parallel Filament		Series Filament	
Filament Voltage DC.....	1.4	1.4	2.8	2.8 Volts
Filament Current.....	100	100	50	50 Ma.
Plate Voltage.....	67.5	90	67.5	90 Volts
Screen Voltage.....	67.5	67.5	67.5	67.5 Volts
Grid Voltage.....	-7	-7	-7	-7 Volts
Peak A-F Grid Voltage.....	7	7	7	7 Volts
Zero Signal Plate Current.....	7.2	7.4	6.0	6.1 Ma.
Zero Signal Screen Current.....	1.5	1.4	1.2	1.1 Ma.
Mutual Conductance.....	1550	1575	1400	1425 μ mhos
Plate Resistance (Approx.).....	0.1	0.1	0.1	0.1 Megohm
Load Resistance.....	5000	8000	5000	8000 Ohms
Total Harmonic Distortion.....	10	12	12	13 Per Cent
Maximum Signal Power Output.....	180	270	160	235 Milliwatts

3S4 (Cont'd)

APPLICATION

Sylvania Type 3S4 is a power amplifier pentode of miniature construction and is very similar to type 1S4 but designed for operation at either 1.4 volts or 2.8 volts. It is particularly suitable as an output tube in compact, light weight, portable equipment which may be operated on batteries or AC-DC power lines. The high operating efficiency allows the tube to be used with light weight low B supply voltages. Circuit applications are similar to those for Sylvania Types 1LB4 and 3Q5GT.

3V4 Sylvania Type

PENTODE POWER AMPLIFIER

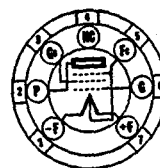

6BX-0-0

PHYSICAL SPECIFICATIONS

Base	Miniature Button 7 Pin
Bulb	T-5 $\frac{1}{2}$
Maximum Overall Length	2 $\frac{1}{4}$ "
Maximum Seated Height	1 $\frac{1}{8}$ "
Mounting Position	Any

Note: With the exception of the base diagram given above the characteristics of type 3V4 are identical with those of type 3Q4 given on a previous page.

5AX4^{GT} Sylvania Type

FULL WAVE RECTIFIER

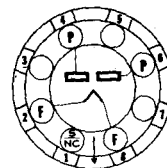

5T-0-0

PHYSICAL SPECIFICATIONS

Base	Intermediate Octal 5-Pin
Bulb	T-9
Maximum Overall Length	3 $\frac{3}{8}$ "
Maximum Seated Height	2 $\frac{13}{16}$ "
Mounting Position	
Vertical	Base up or down
Horizontal	Pins 6 and 8 in vertical plane

RATINGS

Filament Voltage AC or DC	5.0 Volts
Filament Current	2.5 Amperes
Maximum AC Plate Supply Voltage per Plate	
Capacitor Input	350 Volts
Choke Input	500 Volts
Maximum Peak Inverse Plate Voltage	1400 Volts
Maximum Peak Plate Current per Plate	
Steady State	525 Ma.
Transient	3.5 Amperes
Maximum DC Output Current	175 Ma.

TYPICAL OPERATION

FULL WAVE RECTIFIER

	Capacitor	Choke
Input to Filter		
Filament Voltage	5.0	5.0 Volts
AC Plate Supply Voltage per Plate	350	500 Volts
Filter Input Capacitance	10	uf.
Filter Input Inductance		10 Henries
Effective Plate Supply Impedance per Plate	50	Ohms
DC Output Current	175	175 Ma.
DC Output Voltage	330	375 Volts
Tube Voltage Drop, with 175 Ma. DC Plate Current per Plate	65	Volts

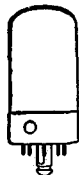

Sylvania Type 5AZ4

FULL-WAVE RECTIFIER

5T-L-0 PHYSICAL SPECIFICATIONS

Base.....	Lock-In 8 Pin
Bulb.....	T-9
Maximum Overall Length.....	3 $\frac{3}{4}$ "
Maximum Seated Height.....	2 $\frac{3}{8}$ "
Mounting Position.....	Vertical†

†Horizontal operation permitted if pins 6 and 8 are in vertical plane.

RATINGS

Filament Voltage AC.....	5.0 Volts
Filament Current.....	2.0 Amperes
Maximum Peak Inverse Voltage.....	1400 Volts
Maximum Steady State Peak Current Per Plate.....	400 Ma.
Maximum Transient Peak Current Per Plate.....	2.2 Amperes
Average Tube Voltage Drop at 125 Ma. Per Plate.....	60. Volts

The maximum values of plate supply voltage and output current are inter-related as well as dependent upon whether choke or condenser input is used. Intermediate values may be determined from the following table:

	Condenser Input			Choke Input	
AC Input Per Plate (RMS)	500	350	70	500	350 Volts
Output Current	85	125	150	125	150 Ma.

TYPICAL OPERATION

	Filter Circuit	
	Choke Input	Condenser Input
Filament Voltage AC.....	5.0	5.0 Volts
Filament Current.....	2.0	2.0 Amperes
AC Plate Voltage Per Plate (RMS).....	500	350 Volts
DC Output Current.....	125	125 Ma.
Minimum Plate Supply Impedance Per Plate.....	10	50 Ohms
Input Choke.....	10	... Henrys

APPLICATION

Sylvania Type 5AZ4 is a lock-in full-wave filament type rectifier having the same ratings as Type 5Y3GT. Reference should be made to this type for the load curve under typical operating conditions.

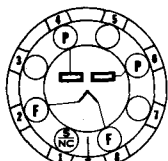

5T-0-0



Sylvania Type 5R4^{GY}

FULL WAVE RECTIFIER

PHYSICAL SPECIFICATIONS

Base.....	Medium Octal 5-Pin
Bulb.....	ST-16
Maximum Overall Length.....	5 $\frac{5}{8}$ "
Maximum Seated Height.....	4 $\frac{3}{8}$ "
Mounting Position*.....	Vertical

*Horizontal operation if pins 1 and 4 are in a vertical plane.

RATINGS

Filament Voltage AC or DC.....	5.0 Volts
Filament Current.....	2.0 Amperes
Maximum Peak Inverse Voltage (No-Load Conditions).....	2800 Volts
Maximum Peak Plate Current.....	.650 Ma.

TYPICAL OPERATION

WITH CONDENSER-INPUT FILTER

AC Plate Voltage per Plate (RMS)	
Full Load.....	900 Volts
No Load.....	1000 Volts
Total Effective Plate-Supply Impedance per Plate**.....	575 Ohms
DC Output Current (Maximum).....	150 Ma.

**For input condenser larger than 4 μ f. a larger plate-supply impedance may be necessary to limit peak plate current to the rated value.

WITH CHOKE-INPUT FILTER

AC Plate Voltage per Plate (RMS)	
Full Load.....	950 Volts
No Load.....	1000 Volts
Input-Choke Inductance (Minimum).....	10 Henrys
DC Output Current (Maximum).....	175 Ma.

APPLICATION

Sylvania Type 5R4GY is a full wave rectifier of the coated filament type. Operating conditions given above apply for use at altitudes up to 20,000 feet.

5U4G Sylvania Type

FULL-WAVE RECTIFIER

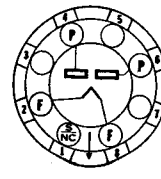

5T-0-0

PHYSICAL SPECIFICATIONS

Base.....	Medium Octal 5-Pin
Bulb.....	ST-16
Maximum Overall Length.....	5 5/16"
Maximum Seated Height.....	4 3/4"
Mounting Position.....	Vertical†

†Horizontal operation permitted if pins 1 and 4 are in vertical plane.

RATINGS

Filament Voltage (AC).....	5.0 Volts
Filament Current.....	3.0 Amperes
Peak Inverse Voltage.....	1550 Volts
Tube Drop at 225 Ma. per Plate.....	58 Volts
Peak Plate Current (Per Plate).....	675 Ma.

TYPICAL OPERATION

	Choke Input*	Condenser Input*
RMS Voltage Per Plate.....	550	450 Volts
DC Output Current (Maximum).....	225	225 Ma.
Plate Supply Impedance (Minimum).....		75 Ohms
Input Choke (Minimum).....	3	... Henrys

*Filter Circuit.

APPLICATION

Sylvania Type 5U4G is a high vacuum full-wave rectifier tube designed for heavier duty service than Type 5Y3G. Choke input filter arrangements are preferred for use with this tube, although somewhat higher plate supply voltages will be required to obtain the same output voltage obtained with condenser input filter circuits, but peak currents are reduced and voltage regulation is greatly improved under variable loads. Type 5U4G is identical to the older Type 5Z3 except for basing.

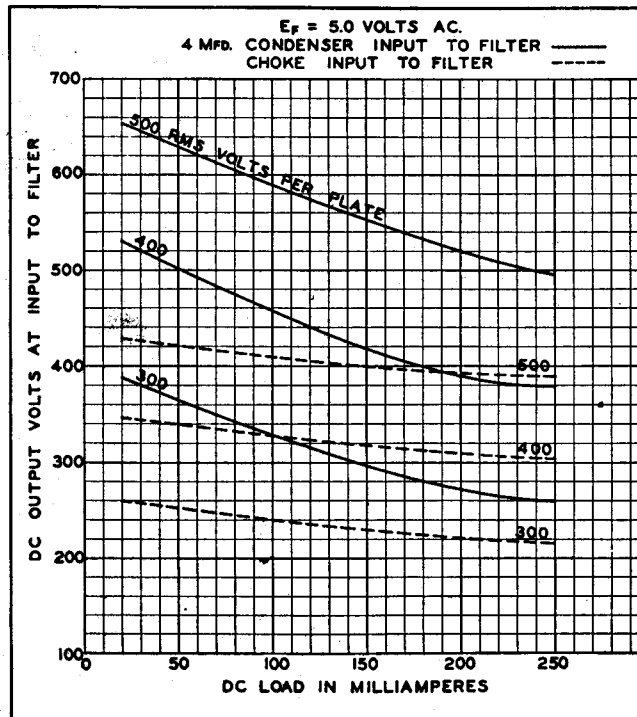

SYLVANIA RADIO TUBES

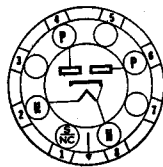

5L-0-0



Sylvania Type 5V4G

FULL-WAVE RECTIFIER

PHYSICAL SPECIFICATIONS

Base.....	Medium Octal 5-Pin
Bulb.....	ST-14
Maximum Overall Length.....	4 5/8"
Maximum Seated Height.....	4 1/4"
Mounting Position.....	Any

RATINGS

AC Heater Voltage.....	5.0 Volts
Heater Current.....	2.0 Amperes
Peak Inverse Voltage.....	1400 Volts
Tube Voltage Drop at 175 Ma. Per Plate.....	25 Volts
Peak Plate Current (Per Plate).....	525 Ma.

TYPICAL OPERATION

CONDENSER INPUT TO FILTER

AC Voltage per Plate (RMS).....	375 Volts Max.
DC Output Current.....	175 Ma. Max.
Plate Supply Impedance per Plate.....	100 Ohms Min.

CHOKE INPUT TO FILTER

AC Voltage per Plate.....	500 Volts Max.
DC Output Current.....	175 Ma. Max.
Input Choke Value.....	4.0 Henrys Min.

APPLICATION

Sylvania 5V4G is a cathode type high vacuum rectifier designed for full-wave applications. This glass tube is identical to Type 83V except that it is equipped with an octal base. It is important to note that the base of this rectifier may contain all eight pins, although only four of these are connected. Sockets designed for Type 5V4G must accommodate the eight pin base. The cathode is connected internally to the heater, similar to the 83V construction.

The filament voltage should be held close to its rated value of 5 volts. Since the filament current is rather high it is necessary to employ wire of the proper current carrying capacity.

The performance of the 5V4G is quite similar to that of any other high vacuum rectifier. Conventional filter circuits, either of the condenser-input or choke-input type, are applicable but care must be exercised so as not to exceed the recommended maximum values of plate voltage and output current. Choke-input filters will reduce the peak plate current and afford improved voltage regulation, although there will be a sacrifice in d-c output voltage.

5V4G (Cont.)

TYPES 5V4G, 83V

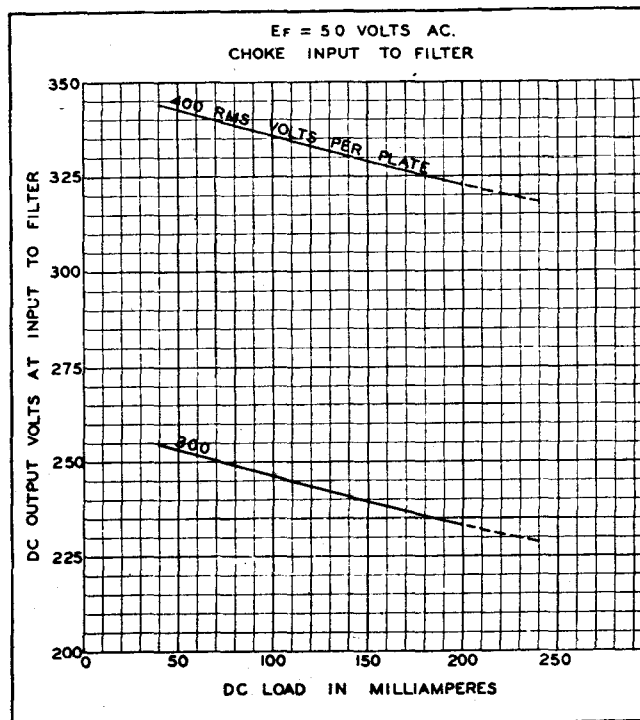
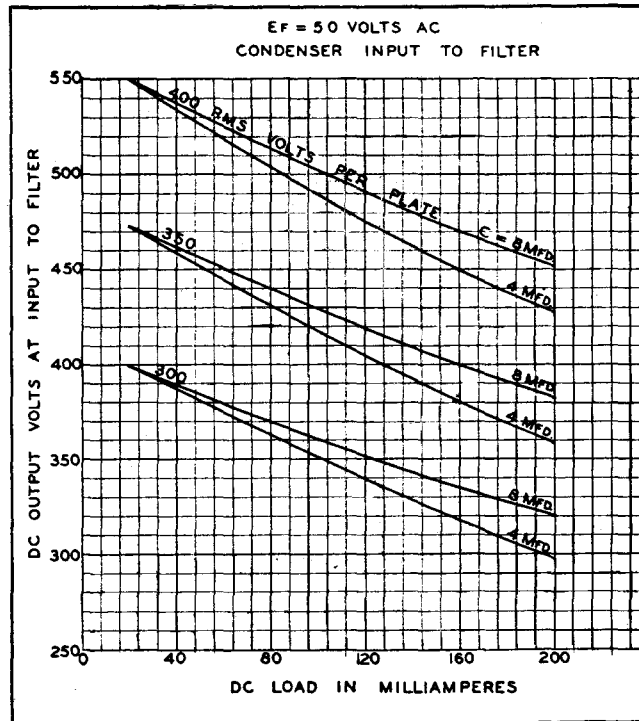

SYLVANIA RADIO TUBES

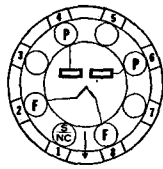

5T-1-0 (5W4)
5T-0-0 (5W4GT)

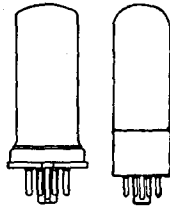

Sylvania Type 5W4^{GT}

FULL-WAVE RECTIFIER

PHYSICAL SPECIFICATIONS

	5W4	5W4GT
Base.....	Small Wafer Octal 5-Pin	Medium Octal 5-Pin
Bulb.....	Metal 8-6	T-9
Maximum Overall Length.....	3 1/4"	3 3/4"
Maximum Seated Height.....	2 1/4"	2 1/4"
Mounting Position.....	Any	Any

RATINGS

Filament Voltage AC.....	5.0 Volts
Filament Current.....	1.5 Amperes
Maximum Peak Inverse Voltage.....	1100 Volts
Tube Voltage Drop at 110 Ma. per Plate.....	50 Volts
Maximum Peak Plate Current (Per Plate).....	300 Ma.

TYPICAL OPERATION

Filament Voltage AC.....	5.0 Volts
Filament Current.....	1.5 Amperes
RMS Voltage Per Plate.....	350 Volts
DC Output Current.....	100 Ma.
Minimum Plate Supply Impedance.....	50 Ohms

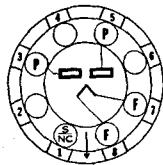

5Q-0-0



Sylvania Type 5X4G

FULL-WAVE RECTIFIER

PHYSICAL SPECIFICATIONS

Base.....	Medium Octal 8-Pin
Bulb.....	ST-16
Maximum Overall Length.....	5 3/4"
Maximum Seated Height.....	4 3/4"
Mounting Position.....	Vertical†

†Horizontal operation permitted if pins 1 and 4 are in a vertical plane.

For operation data, and curves refer to corresponding Type 5U4G which is identical except for basing.

Sylvania Type **5Y3GT**
 Sylvania Type **5Y4G**

FULL-WAVE RECTIFIER

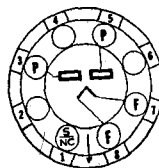

5Q-0-0
5Y4G

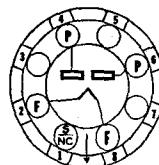

5T-0-0
5Y3GT

PHYSICAL SPECIFICATIONS

	5Y3GT	5Y4G
Base.....	Intermediate Octal 5-Pin	Medium Octal 8-Pin
Bulb.....	T-9	ST-14
Maximum Overall Length.....	3 3/8"	4 5/8"
Maximum Seated Height.....	2 1/8"	4 1/8"
Mounting Position.....	Vertical*	Vertical†

*Horizontal operation permitted if Pins 2 and 4 are in a vertical plane.

†Horizontal operation permitted if Pins 1 and 4 are in a vertical plane.

RATINGS

Filament Voltage AC.....	5.0 Volts
Filament Current.....	2.0 Amperes
Maximum Peak Inverse Voltage.....	1400 Volts
Maximum Steady State Peak Current per Plate.....	375 Ma.
Maximum Transient Peak Current per Plate.....	2.2 Amperes
Average Tube Voltage Drop at 125 Ma. per Plate.....	60 Volts

The maximum values of plate supply voltage and output current are inter-related as well as dependent upon whether choke or condenser input is used. Intermediate values may be determined from the following table:

	Condenser Input			Choke Input	
AC Input per Plate (RMS).....	500	350	70	500	350 Volts
Output Current.....	85	125	150	125	150 Ma.

TYPICAL OPERATION

	Filter Circuit	
	Choke Input	Condenser Input
Filament Voltage AC.....	5.0	5.0 Volts
Filament Current.....	2.0	2.0 Amperes
AC Plate Voltage per Plate (RMS).....	500	350 Volts
DC Output Current.....	125	125 Ma.
Minimum Plate Supply Impedance per Plate.....	10	50 Ohms
Input Choke.....	10	... Henrys

APPLICATION

Sylvania Types 5Y3GT and 5Y4G are full-wave vacuum type rectifiers similar to Type 80 and are used for supplying direct current power from an a-c power supply line.

The filament employed in these types is of the oxide coated type. This filament is operated on alternating current from a five volt winding on the power transformer. The filament voltage should be held close to its rated value of 5 volts. Since the filament current is rather high (2.0 amperes) it is necessary to employ wire of the proper current carrying capacity. It is unnecessary to provide the filament winding with a center tap for most applications.

(Curves are shown on the following page).

(Cont.) 5Y3^{GT}

(Cont.) 5Y4G

TYPES 5Y3G, 5Y4G, 80

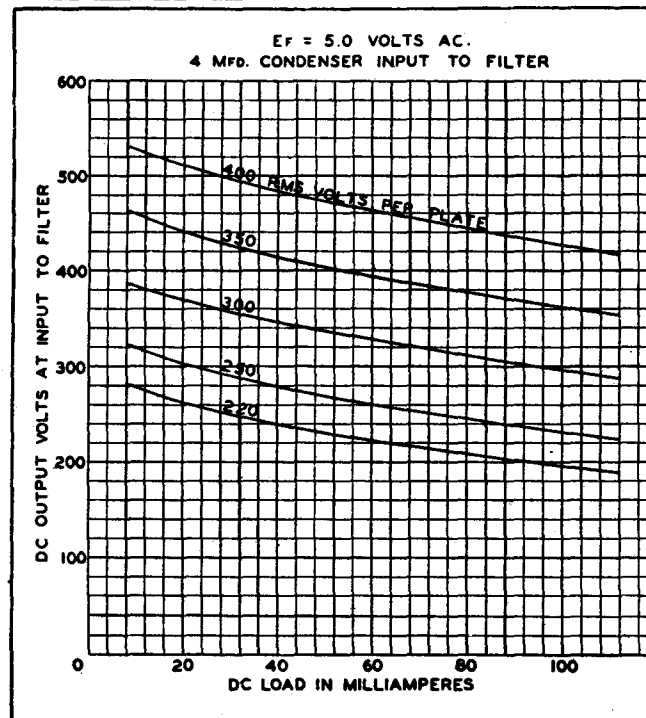
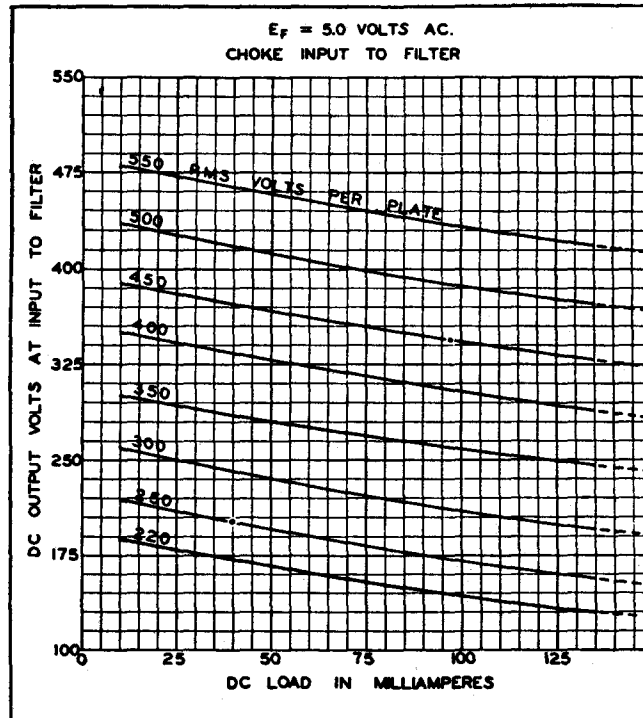

SYLVANIA RADIO TUBES

5Z3 Sylvania Type

FULL-WAVE RECTIFIER

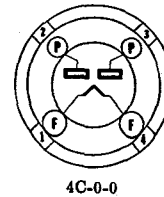

4C-0-0

PHYSICAL SPECIFICATIONS

Base.....	Medium 4-Pin
Bulb.....	ST16
Maximum Overall Length.....	5 3/8"
Maximum Seated Height.....	4 3/4"
Mounting Position.....	Vertical†

†Horizontal operation permitted if pins 1 and 2 are in a vertical plane.

For further data on this type, refer to corresponding Type 5U4G, which is identical except for basing.

5Z4^{GT} Sylvania Type

FULL-WAVE RECTIFIER

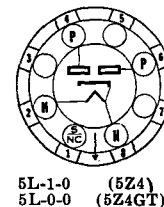
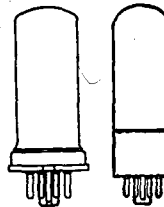

5L-1-0 (5Z4)
5L-0-0 (5Z4GT)

PHYSICAL SPECIFICATIONS

	5Z4	5Z4GT
Base.....	Small Wafer Octal 5 Pin	Intermediate Octal 5 Pin
Bulb.....	Metal 8-6	T9
Maximum Overall Length.....	3 3/4"	3 3/8"
Maximum Seated Height.....	2 11/16"	2 15/16"
Mounting Position.....	Any	Any

RATINGS

Heater Voltage.....	5.0 Volts
Heater Current.....	2.0 Ampere
Peak Inverse Voltage.....	1400 Volts
Peak Plate Current per Plate.....	375 Ma.
Tube Drop at 125 Ma. per Plate.....	20 Volts

TYPICAL OPERATION

	Choke Input	Condenser Input
Heater Voltage.....	5.0	5.0 Volts
Heater Current.....	2.0	2.0 Ampere
RMS Voltage Per Plate.....	500	350 Volts
DC Output Current.....	125	125 Ma.
Minimum Plate Supply Impedance Per Plate.....		50 Ohms
Minimum Input Choke.....	5.0	Henry's

6A5G Sylvania Type

POWER AMPLIFIER TRIODE

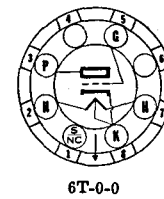

6T-0-0

PHYSICAL SPECIFICATIONS

Base.....	Medium Octal 8 Pin
Bulb.....	ST16
Maximum Overall Length.....	5 3/8"
Maximum Seated Height.....	4 3/4"
Mounting Position.....	Any

RATINGS

Heater Voltage.....	6.3 Volts
Heater Current.....	1.25 Amperes
Maximum Plate Voltage.....	325 Volts
Maximum Plate Dissipation.....	15 Watts

Direct Interelectrode Capacitances:*

Grid to Plate.....	16 μ f.
Input.....	7 μ f.
Output.....	5 μ f.

*Unshielded.

TPYICAL OPERATION as Amplifier

	Class A One Tube	Push-Pull Class AB ₁ Two Tubes	
		Fixed Bias	Self Bias
Heater Voltage.....	6.3	6.3	6.3 Volts
Heater Current.....	1.25	1.25	1.25 Amperes
Plate Voltage.....	250	325	325 Volts
Grid Voltage.....	-45	-68 Volts
Self-Bias Resistor.....	750	850 Ohms
Plate Current (Per Tube).....	60	40	40 Ma.
Plate Resistance.....	800 Ohms
Mutual Conductance.....	5250 μ mhos
Amplification Factor.....	4.2
Load Resistance (Total).....	2500	3000	5000 Ohms
Power Output.....	3.75	15	10 Watts
Harmonic Distortion.....	5.0	2.5	5.0 Per Cent

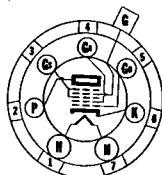

7C-0-0

**Sylvania Type 6A7****HEPTODE CONVERTER****PHYSICAL SPECIFICATIONS**

Base.....	Small 7 Pin
Bulb.....	ST12
Cap.....	Small Metal
Maximum Overall Length.....	4 $\frac{1}{2}$ "
Maximum Seated Height.....	3 $\frac{3}{4}$ "
Mounting Position.....	Any

RATINGS

Heater Voltage AC or DC.....	6.3 Volts
Heater Current.....	300 Ma.
Maximum Plate Voltage.....	300 Volts
Maximum Screen Voltage.....	100 Volts
Maximum Screen Supply.....	300 Volts
Maximum Anode-Grid Supply.....	300 Volts
Maximum Anode-Grid Voltage.....	200 Volts
Maximum Plate Dissipation.....	1.0 Watt
Maximum Screen Dissipation.....	0.3 Watt
Maximum Anode-Grid Dissipation.....	0.75 Watt
Maximum Cathode Current.....	14 Ma.
Maximum Heater-Cathode Voltage.....	90 Volts

For typical operating conditions see Type 6A8G.

6A8G/GT Sylvania Type

HEPTODE CONVERTERS

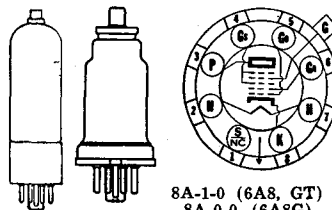

8A-1-0 (6A8, GT)
8A-0-0 (6A8G)

PHYSICAL SPECIFICATIONS

	6A8	6A8G	6A8GT
Base.....	Small Wafer	Small	Small Wafer
Bulb.....	Octal 8 Pin	Octal 8 Pin	Octal 8 Pin
Cap.....	Metal 8-4	ST12	Metal Sleeve
Maximum Overall Length.....	Miniature	Miniature	Miniature
Maximum Seated Height.....	3 1/8"	4 17/32"	3 3/8"
Mounting Position.....	2 5/8"	3 3/8"	2 3/8"
	Any	Any	Any

TYPICAL OPERATION

Heater Voltage.....	6.3	6.3 Volts
Heater Current.....	300	300 Ma.
Plate Voltage.....	100	250 Volts
Signal Grid Voltage.....	-1.5	-3.0 Volts
Screen Voltage.....	50	100 Volts
Anode-Grid Voltage.....	100	250* Volts
Oscillator Grid Resistance.....	50,000	50,000 Ohms
Plate Current.....	1.1	3.5 Ma.
Screen Current.....	1.3	2.7 Ma.
Anode-Grid Current.....	2.0	4.0 Ma.
Oscillator Grid Current.....	0.25	0.4 Ma.
Self-Bias Resistor.....	300	300 Ohms
Plate Resistance.....	0.5	0.3 Megohm
Conversion Conductance.....	360	550 μmhos
Conversion Conductance at		
Signal Grid Bias of -20 (Approx.).....	3 μmhos
Signal Grid Bias of -35 (Approx.).....		6 μmhos

*Through a 20,000 ohm resistor.
For ratings, refer to Type 6A7. Other data will be found under Lock-In Type 7B8 which is nearly identical in electrical characteristics.

6AB4 Sylvania Type

RF TRODE

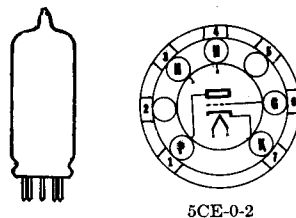

5CE-0-2

PHYSICAL SPECIFICATIONS

Base.....	Miniature Button 7-Pin
Bulb.....	T-51 1/2
Maximum Overall Length.....	2 3/8"
Maximum Seated Height.....	1 7/8"
Mounting Position.....	Any

RATINGS

Heater Voltage AC or DC.....	6.3 Volts
Maximum Plate Voltage.....	300 Volts
Maximum Plate Dissipation.....	2.5 Watts
Maximum Heater-Cathode Voltage.....	90 Volts
Maximum Negative Control DC Grid Voltage.....	-50 Volts

Direct Interelectrode Capacitances:

	Shielded*	Unshielded
Grid to Plate.....	1.5	1.5 μf.
Input.....	2.4	2.2 μf.
Output.....	1.4	0.50 μf.
(Grounded Grid Operation)		
Plate to Cathode.....	0.20	0.24 μf.
Input.....	5.2	5.0 μf.
Output.....	2.6	1.7 μf.

*RMA standard shield No. 316.

It is recommended that pin number 2 be grounded.

TYPICAL OPERATION**CLASS A₁ AMPLIFIER**

Heater Voltage AC or DC	6.3	6.3 Volts
Heater Current	150	150 Ma.
Plate Voltage	100	250 Volts
Cathode Resistor	270	200 Ohms
Plate Current	3.7	10 Ma.
Plate Resistance	15,000	10,900 Ohms
Mutual Conductance	4,000	5,500 μ mhos
Amplification Factor	60	60
Control Grid Voltage (approx.) for $I_b = 10 \mu$ a.	-5	-12 Volts

APPLICATION

Sylvania Type 6AB4 is a miniature triode to be used as a ground-grid rf amplifier, frequency converter or oscillator at frequencies below 300 megacycles.

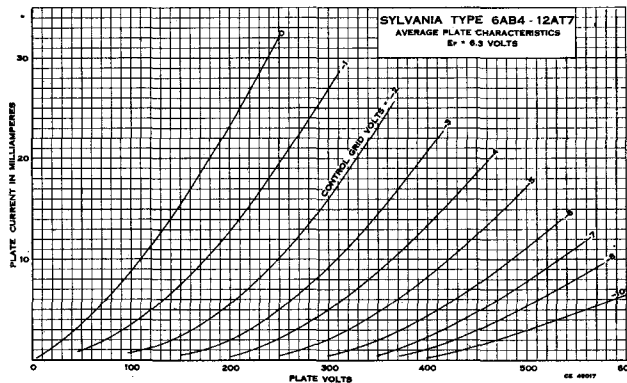

6Q-0-0

**6AC5^{GT} Sylvania Type****HIGH-MU POWER AMPLIFIER****TRIODE****PHYSICAL SPECIFICATIONS**

Base	Intermediate Octal 6 Pin
Bulb	T9
Maximum Overall Length	3 $\frac{1}{2}$ "
Maximum Seated Height	2 $\frac{3}{4}$ "
Mounting Position	Any

RATINGS

Maximum Plate Supply Voltage	250 Volts
Maximum Plate Dissipation	10 Watts
Maximum Heater-Cathode Voltage	90 Volts
Maximum Peak Plate Current per Tube	110 Ma.

TYPICAL OPERATION FOR TWO TUBES:

Heater Voltage	6.3 Volts
Heater Current	0.4 Ampere
Plate Voltage	250 Volts
Grid Voltage	0 Volt
Peak Input Signal (Grid to Grid)	70 Volts
DC Plate Current (Zero Signal)	5 Ma.
Load Resistance (Plate to Plate)	10000 Ohms
Power Output †	8 Watts

†With peak input of 950 milliwatts to grids.

6AC7/1852 Sylvania Type

TELEVISION AMPLIFIER PENTODE



8N-1-1

PHYSICAL SPECIFICATIONS

Base.....	Small Wafer Octal 8 Pin
Bulb.....	Metal 8-1
Maximum Overall Length.....	2 3/4"
Maximum Seated Height.....	2 1/4"
Mounting Position.....	Any

RATINGS

Heater Voltage.....	6.3 Volts
Heater Current.....	0.450 Ampere
Maximum Plate Voltage.....	300 Volts
Maximum Screen Supply Voltage.....	300 Volts
Maximum Screen Voltage.....	150 Volts
Maximum Plate Dissipation.....	3.02 Watts
Maximum Screen Dissipation.....	0.38 Watt
Maximum Grid Resistor*	
Self Bias Fixed Screen Voltage.....	0.25 Megohm
Self Bias Series Screen Resistor.....	0.50 Megohm
Self-Bias Resistor (Minimum).....	160 Ohms
Maximum Heater-Cathode Voltage.....	90 Volts

*For maximum voltage conditions.

Direct Interelectrode Capacitances:†

Grid to Plate.....	0.015 μ f. Max.
Input.....	11 μ f.
Output.....	5 μ f.

†With shell connected to cathode.

TYPICAL OPERATION CLASS A₁

Heater Voltage.....	6.3	6.3 Volts
Heater Current.....	0.450	0.450 Ampere
Plate Voltage.....	300	300 Volts
Screen Supply Voltage.....	150	300 Volts
Screen Resistor.....		60000 Ohms
Suppressor Grid Voltage.....	0	0 Volts
Self-Bias Resistor.....	160	160 Ohms
Plate Current.....	10	10 Ma.
Screen Current.....	2.5	2.5 Ma.
Mutual Conductance.....	9000	9000 μ mhos
Plate Resistance (Approximate).....	1.0	1.0 Megohm

6AD4 Sylvania Type

HIGH MU TRIODE

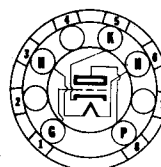

8DK-0-0

PHYSICAL SPECIFICATIONS

Base.....	Flexible Leads
Bulb.....	T-3
Maximum Overall Bulb Length.....	1 3/4"
Minimum Lead Length.....	1 1/2"
Mounting Position.....	Any

RATINGS

Heater Voltage AC or DC.....	6.3 Volts
Maximum Plate Voltage.....	150 Volts
Maximum Plate Dissipation.....	0.3 Watt
Maximum Heater-Cathode Voltage.....	90 Volts
Maximum Cathode Current.....	2 Ma.
Maximum Control Grid Circuit Resistance (cathode bias).....	1 Megohm

Direct Interelectrode Capacitances:

	Unshielded	Shielded*
Grid to Plate.....	0.80	0.70 μ f.
Input.....	1.70	1.90 μ f.
Output.....	0.70	2.20 μ f.

*External shield of 0.405" diameter connected to cathode.

SYLVANIA RADIO TUBES

TYPICAL OPERATION CLASS A₁ AMPLIFIER

Heater Voltage.....	6.3 Volts
Heater Current.....	150 Ma.
Plate Voltage.....	100 Volts
Cathode Bias Resistor.....	820 Ohms
Plate Current.....	1.4 Ma.
Mutual Conductance.....	2000 μ mhos
Amplification Factor.....	70
Plate Resistance.....	35,000 Ohms
Control Grid Voltage for I _b = 10 μ a.....	-3.0 Volts

For use in resistance coupled circuits, see data in appendix.

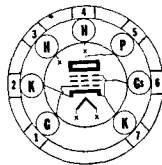

7BD-0-2 & 7



Sylvania Type 6AG5

SHARP CUT-OFF RF PENTODE

PHYSICAL SPECIFICATIONS

Base.....	Miniature Button 7 Pin
Bulb.....	T-5 $\frac{1}{2}$
Maximum Overall Length.....	2 $\frac{1}{8}$ "
Maximum Seated Height.....	1 $\frac{3}{8}$ "
Mounting Position.....	Any

RATINGS

Heater Voltage AC or DC.....	6.3 Volts
Heater Current.....	300 Ma.
Maximum Plate Voltage.....	300 Volts
Maximum Screen Voltage.....	150 Volts
Maximum Plate Dissipation.....	2 Watts
Maximum Screen Dissipation.....	0.5 Watt
Maximum Heater-Cathode Voltage.....	90 Volts

Direct Interelectrode Capacitances: (Without External Shield)

Grid to Plate.....	0.025 μ f. Max.
Input.....	6.5 μ f.
Output.....	1.8 μ f.

TYPICAL OPERATION CLASS A₁ AMPLIFIER

PENTODE CONNECTION

Heater Voltage.....	6.3	6.3	6.3 Volts
Heater Current.....	300	300	300 Ma.
Plate Voltage.....	100	125	250 Volts
Screen Voltage.....	100	125	150 Volts
Self-Bias Resistor.....	100	100	200 Ohms
Plate Current.....	5.5	7.2	7.0 Ma.
Screen Current.....	1.6	2.1	2.0 Ma.
Grid Bias for 10 μ a Plate Current.....	-5.0	-6.0	-8.0 Volts
Plate Resistance (Approx.).....	0.3	0.5	0.8 Megohm
Transconductance.....	4750	5100	5000 μ mhos

TRIODE CONNECTION

Heater Voltage.....	6.3	6.3 Volts
Heater Current.....	300	300 Ma.
Plate Voltage.....	180	250 Volts
Self-Bias Resistor.....	350	825 Ohms
Plate Current.....	7.0	5.5 Ma.
Plate Resistance.....	7900	11,000 Ohms
Amplification Factor.....	45	42
Transconductance.....	5700	3800 μ mhos

APPLICATION

Sylvania Type 6AG5 is a sharp cut-off pentode of miniature construction having high mutual conductance. It is useful as a RF amplifier for frequencies up to 400 megacycles. Input and output capacitances are low and the dual cathode leads aid in preventing degeneration, by providing the means for cathode return isolation.

6AG5 (Cont.)

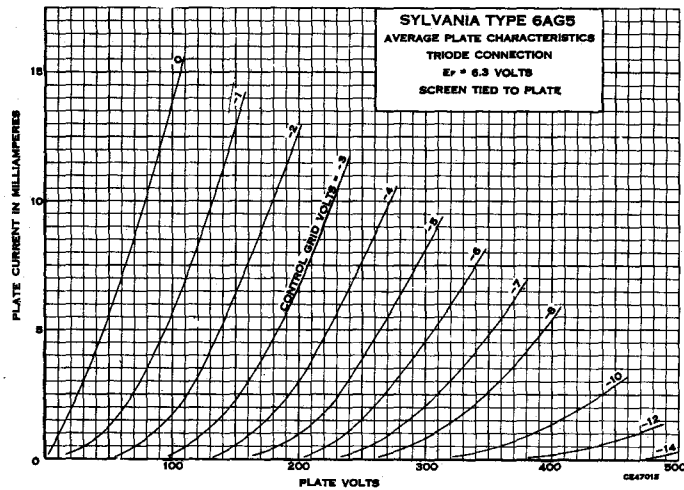
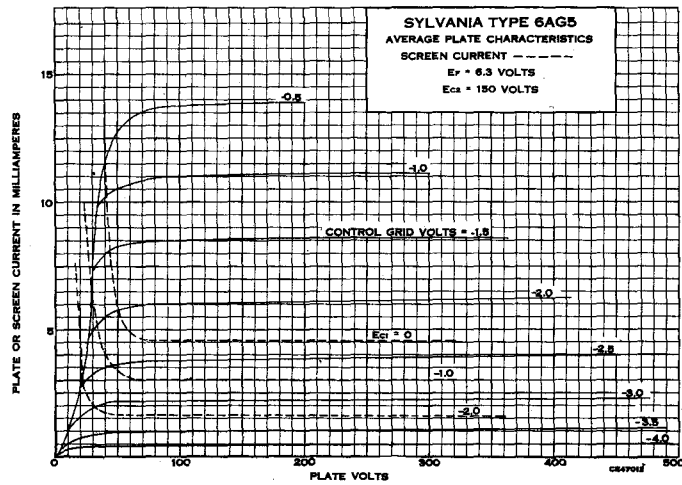



8Y-1-3



Sylvania Type 6AG7

TELEVISION AMPLIFIER PENTODE

PHYSICAL SPECIFICATIONS

Base.....	Small Wafer Octal 8 Pin
Bulb.....	Metal 8-6
Maximum Overall Length.....	3 1/2"
Maximum Seated Height.....	2 11/16"
Mounting Position.....	Vertical§

§Horizontal if plane of pins number 2 and 7 is vertical.

RATINGS

Heater Voltage AC or DC.....	6.3 Volts
Heater Current.....	0.650 Ampere
Maximum Plate Voltage.....	300 Volts
Maximum Screen Voltage.....	300 Volts
Maximum Plate Dissipation.....	9.0 Watts
Maximum Screen Dissipation.....	1.5 Watts
Minimum External Control Grid Voltage.....	0 Volts
Maximum Heater-Cathode Voltage.....	90 Volts

Direct Interelectrode Capacitances: Shell Connected to Cathode.

Grid to Plate.....	0.060 μ mf. Max.
Input.....	13.0 μ mf.
Output.....	7.5 μ mf.

TYPICAL OPERATION

CLASS A₁ AMPLIFIER

Heater Voltage.....	6.3 Volts
Heater Current.....	0.650 Ampere
Plate Voltage.....	300 Volts
Screen Voltage.....	150 Volts
Control Grid Voltage*.....	3.0 Volts
Self-Bias Resistor.....	81 Ohms
Peak AF Signal Voltage.....	3.0 Volts
Plate Resistance.....	0.13 Megohm
Mutual Conductance.....	11000 μ mhos
Zero Signal Plate Current.....	30 Ma.
Maximum Signal Plate Current.....	30.5 Ma.
Zero Signal Screen Current.....	7.0 Ma.
Maximum Signal Screen Current.....	9.0 Ma.
Load Resistance.....	10000 Ohms
Power Output.....	3.0 Watts
Total Distortion.....	7.0 Per Cent

*Maximum grid circuit resistance should not exceed 0.25 megohm if fixed bias is used, or 1.0 megohm if self-bias is used.

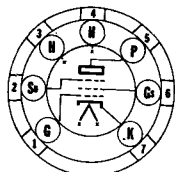

7BK-0-0



Sylvania Type 6AH6

SHARP CUT-OFF RF PENTODE

PHYSICAL SPECIFICATIONS

Base.....	Small Button Miniature 7 Pin
Bulb.....	T-5 1/2"
Maximum Overall Length.....	2 3/8"
Maximum Seated Height.....	1 3/8"
Mounting Position.....	Any

RATINGS

Heater Voltage AC or DC.....	6.3 Volts
Maximum Plate Voltage.....	300 Volts
Maximum Screen Voltage.....	150 Volts
Maximum Plate Dissipation.....	3.2 Watts
Maximum Screen Dissipation.....	0.4 Watts
Maximum Cathode Current.....	13.0 Ma.
Maximum Heater-Cathode Voltage.....	90 Volts

6AH6 (Cont'd)

Direct Interelectrode Capacitances:*

Grid to Plate.....	.020 μ f. Max
Input.....	10 μ f.
Output.....	3.6 μ f.

*With $\frac{3}{4}$ " diameter shield (RMA No. 316) connected to cathode.

TYPICAL OPERATION

	Pentode Connection	Triode Connection
Heater Voltage AC or DC.....	6.3	6.3 Volts
Heater Current.....	450	450 Ma.
Plate Voltage.....	300	150
Screen Voltage.....	150	150
Suppressor Grid Voltage.....	tie to K	tie to P
Control Grid Voltage.....	Obtained by 160 Ohm Cathode Resistor	
Plate Resistance (Approx.).....	500,000	3600 Ohms
Mutual Conductance.....	9,000	11,000 μ mhos
Amplification Factor.....	10	40
Plate Current.....	10	12.5 Ma.
Screen Current.....	2.5	Ma.
Control Grid Voltage for $I_b=10 \mu$ a (Approx.).....	-7.0	-7.0 Volts

APPLICATION

Sylvania Type 6AH6 is a sharp cut-off pentode designed for use in television, video and I.F. circuits where wide band amplification or low impedance output is required. The triode rating is to permit its use in cathode follower circuits.

The suppressor grid is not designed to have a large enough control characteristic for practical use.

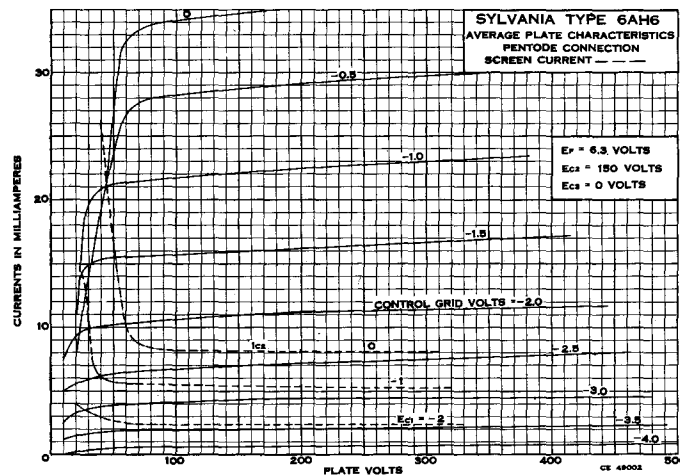

6AJ5 Sylvania Type

SHARP CUT-OFF PENTODE

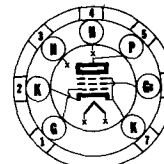

7BD-0-0

PHYSICAL SPECIFICATIONS

Base.....	Miniature Button 7-Pin
Bulb.....	T-5 $\frac{1}{2}$ "
Maximum Overall Length.....	1 $\frac{3}{4}$ "
Maximum Seated Height.....	1 $\frac{1}{2}$ "
Mounting Position.....	Any

SYLVANIA RADIO TUBES

RATINGS

Heater Voltage AC or DC	6.3 Volts
Maximum Plate Voltage	180 Volts
Maximum Screen Supply Voltage	180 Volts
Maximum Plate Dissipation	1.7 Watts
Maximum Screen Dissipation	0.5 Watt
Maximum Positive Control DC Grid Voltage	0 Volts
Maximum Cathode Current	18 Ma.

Direct Interelectrode Capacitances:

	Shielded*	Unshielded
Grid to Plate	0.02	0.03 μ f.
Input	4.0	4.0 μ f.
Output	2.8	2.1 μ f.

*External shield connected to pins 2 and 7.

TYPICAL OPERATION**CLASS A₁ AMPLIFIER**

Heater Voltage	6.3 Volts
Heater Current	175 Ma.
Plate Voltage	28 Volts
Screen Grid Voltage	28 Volts
Control Grid Voltage	-1 Volt
Plate Resistance (approx.)	0.1 Megohm
Mutual Conductance	2,500 μ mhos
Plate Current	2.7 Ma.
Screen Grid Current	1 Ma.
Control Grid Voltage for $I_b = 10 \mu$ a.	-4.5 Volts

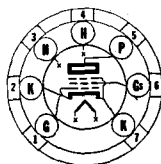

7BD-0-2 & 7

**Sylvania Type 6AK5**

RF AMPLIFIER PENTODE

PHYSICAL SPECIFICATIONS

Base	Miniature Button 7 Pin
Bulb	T-5 $\frac{1}{2}$
Maximum Overall Length	1 $\frac{3}{4}$ "
Maximum Seated Height	1 $\frac{1}{2}$ "
Mounting Position	Any

RATINGS

Heater Voltage AC or DC	6.3 Volts
Heater Current	0.175 Ampere
Maximum Plate Voltage	180 Volts
Maximum Screen Volts	140 Volts
Maximum Plate Dissipation	1.7 Watts
Maximum Screen Dissipation	0.5 Watt
Maximum DC Heater-Cathode Voltage	90 Volts
Maximum Cathode Current	18 Ma.

Direct Interelectrode Capacitances:*

Grid to Plate	0.02 μ f. Max.
Input	4.0 μ f.
Output	2.8 μ f.

*With a close fitting shield connected to the cathode.

6AK5 (Cont'd)

TYPICAL OPERATION CLASS A₁ AMPLIFIER

Heater Voltage.....	6.3	6.3 Volts
Heater Current.....	175	175 Ma.
Plate Voltage.....	120	180 Volts
Screen Voltage.....	120	120 Volts
Cathode Resistor**.....	180	180 Ohms
Plate Resistance (approx.).....	0.30	0.50 Megohm
Mutual Conductance.....	5000	5100 μ mhos
Plate Current.....	7.5	7.7 Ma.
Screen Current.....	2.5	2.4 Ma.

**Fixed Bias Operation is not recommended.

APPLICATION

Sylvania Type 6AK5 is a high-frequency, high mutual conductance pentode of miniature style of construction. It is intended for use at frequencies up to approximately 400 megacycles and the dual cathode leads, when properly used, help to isolate input and output circuits, thereby permitting greater gain per stage.

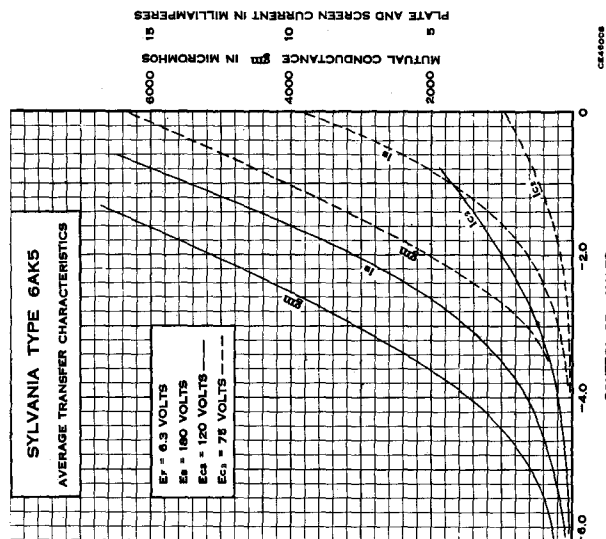
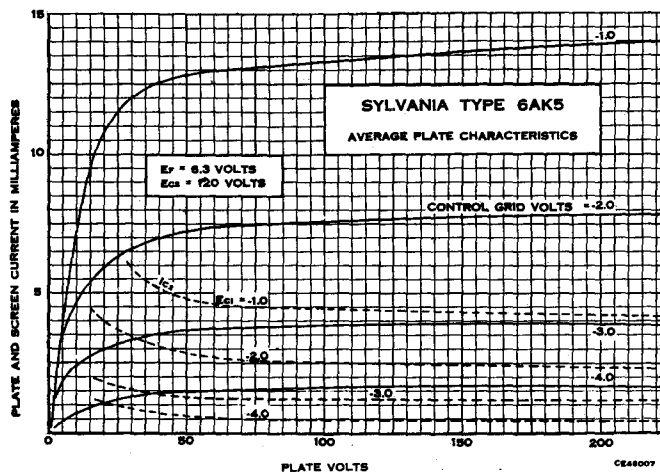



7BK-0-0



Sylvania Type 6AK6

PENTODE POWER AMPLIFIER

PHYSICAL SPECIFICATIONS

Base	Miniature Button 7-Pin
Bulb	T-51 $\frac{1}{2}$
Maximum Overall Length	2 $\frac{1}{8}$ "
Maximum Seated Height	1 $\frac{1}{8}$ "
Mounting Position	Any

RATINGS

Heater Voltage AC or DC	6.3 Volts
Heater Current	150 Ma.
Maximum Plate Voltage	300 Volts
Maximum Screen Voltage	250 Volts
Maximum Plate Dissipation	2.75 Watts
Maximum Screen Dissipation	0.75 Watts
Maximum DC Heater-Cathode Voltage	100 Volts

Direct Interelectrode Capacitances:*

Grid to Plate	0.12 μ f.
Input	3.6 μ f.
Output	4.2 μ f.

*Without external shield.

TYPICAL OPERATION

A.F. POWER AMPLIFIER

Heater Voltage	6.3 Volts
Heater Current	150 Ma.
Plate Voltage	180 Volts
Suppressor	Connected to Cathode at Socket
Screen Voltage	180 Volts
Grid Voltage	-9 Volts
Peak AF Grid Voltage	9 Volts
Zero Signal Plate Current	15 Ma.
Zero Signal Screen Current	2.5 Ma.
Plate Resistance	0.2 Megohm
Transconductance	2300 μ mhos
Load Resistance	10,000 Ohms
Total Harmonic Distortion	10 %
Maximum Signal Power Output	1.1 Watts

APPLICATION

Sylvania Type 6AK6 is a power amplifier pentode designed for use in compact light-weight radio equipment. It is similar in characteristics to Sylvania Type 6G6G.

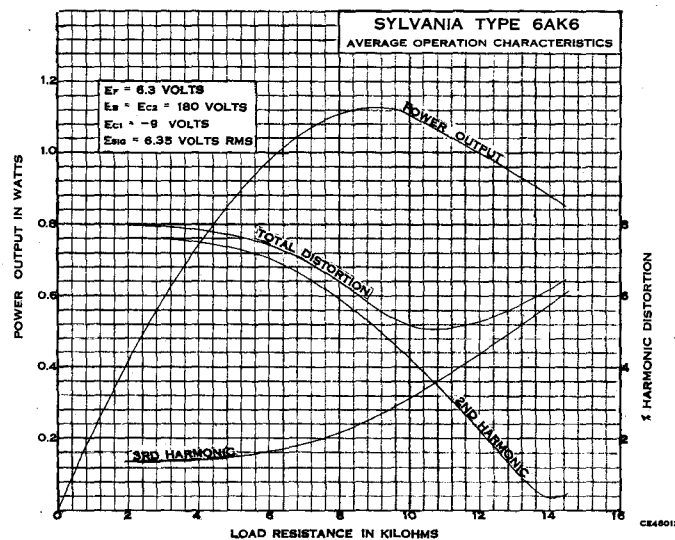

6AK6 (Cont'd)

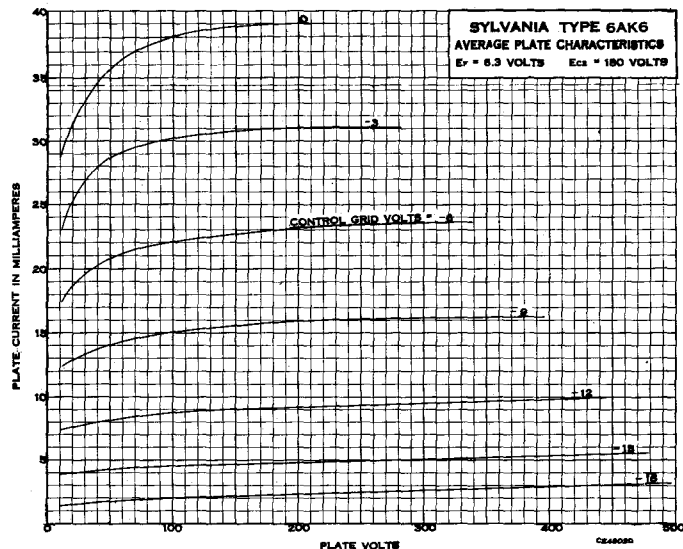

6AL5 Sylvania Type

DUODIODE

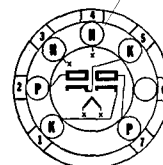

6BT-0-6

PHYSICAL SPECIFICATIONS

Base.....	Miniature Button 7 Pin
Bulb.....	T5 1/2
Maximum Overall Length.....	1 3/4"
Maximum Seated Height.....	1 1/2"
Mounting Position.....	Any

RATINGS

Heater Voltage AC or DC.....	6.3 Volts
Heater Current.....	0.3 Ampere
Maximum Peak Inverse Plate Voltage.....	330 Volts
Maximum Peak Plate Current per Plate.....	54 Ma.
Maximum DC Output Current per Plate.....	9.0 Ma.
Maximum DC Heater-Cathode Voltage.....	330 Volts

Direct Interelectrode Capacitances:

	Unshielded	Shielded*
Plate Input each Unit.....	2.5	3.2 μ f.
Coupling Plate to Plate.....	.068	.026 μ f.
Cathode Input each Unit.....	3.4	3.6 μ f.

*With a 3/4" diameter shield (RMA Std. 316) connected to internal shield.

TYPICAL OPERATION AS A HALF WAVE RECTIFIER

AC Voltage Per Plate (RMS).....	117 Volts
Minimum Effective Plate Supply Impedance.....	300 Ohms
DC Output Current Per Plate.....	9.0 Ma.

APPLICATION

Sylvania Type 6AL5 is a double diode of miniature type of construction. It is designed especially for high-frequency operation having a resonant frequency per unit of approximately 700 megacycles. Each diode unit is completely separate from the other and isolated by means of an internal shield thus permitting independent operation of each diode.

In ratio detector service, use of a series resistor to operate the heater at a voltage of 5.3 volts is recommended. This provides considerably lower hum output without loss of performance.

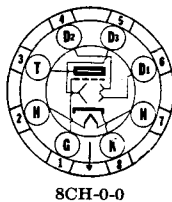
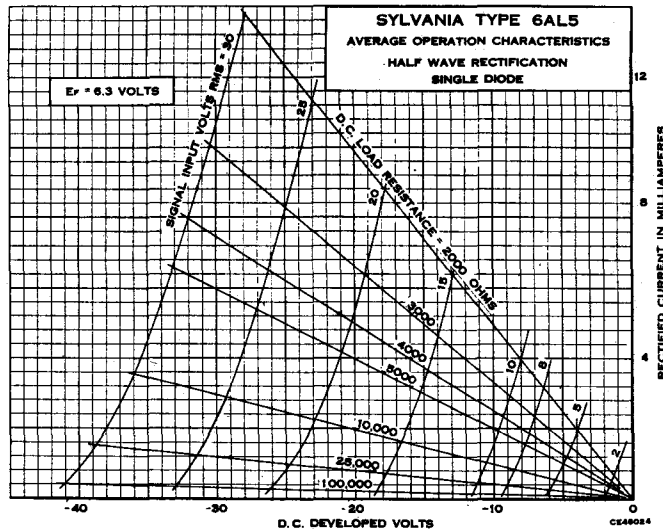

SCH-0-0

Sylvania Type 6AL7^{GT}

TUNING INDICATOR

PHYSICAL SPECIFICATIONS

Base	Intermediate Shell 8 Pin Octal
Bulb	T-9
Maximum Overall Length	3 1/16"
Maximum Seated Height	2 1/2"
Mounting Position	Any

RATINGS

Heater Voltage	6.3 Volts
Maximum Target Voltage	365 Volts
Minimum Target Voltage	220 Volts
Maximum Heater-Cathode Voltage	90 Volts

TYPICAL OPERATION

TUNING INDICATOR SERVICE

Heater Voltage	6.3 Volts
Heater Current	150 Ma.
Target Voltage	315 Volts
Control Grid Voltage*	0 Volts
Deflection Electrode Voltages†	0 Volts
Deflection Sensitivity (Approx.)	1 mm per Volt
Control Grid Voltage for Fluorescent Cut-Off (Approx.)	-6.0 Volts
Cathode Bias Resistor (Approx.)	3300 Ohms

*When not used for fluorescent control the grid should be connected to the cathode.

†The illustration shows the fluorescent areas controlled by the deflection electrodes connected to D1, D2 and D3 respectively.

6AL7GT (Cont'd)

APPLICATION

Sylvania Type 6AL7GT is a tuning indicator tube using the principle of the cathode ray tube and designed for use with FM circuits. The fluorescent coating is applied to a mica screen and the relative values of the voltages applied to the deflection electrodes are indicated by the location and size of the illuminated area.

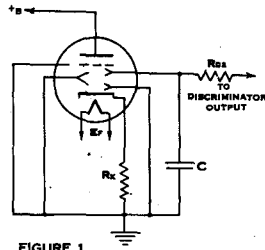

FIGURE 1

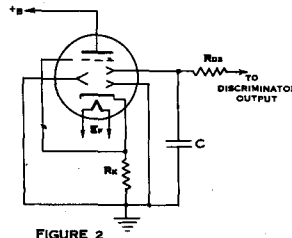

FIGURE 2

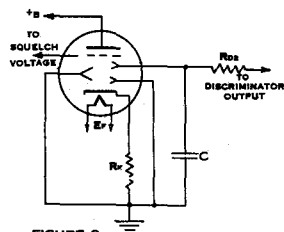

FIGURE 3
SQUELCH VOLTAGE
e.v. (APPROX) = OFF CHANNEL

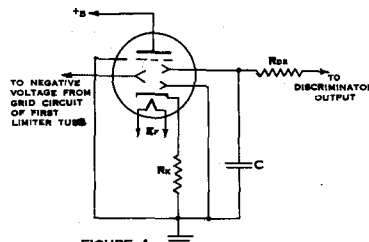

FIGURE 4

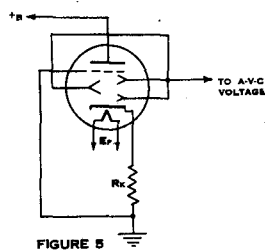
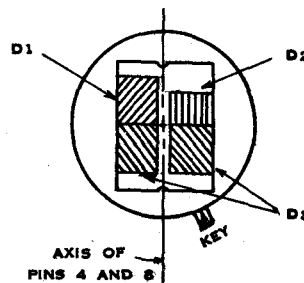

FIGURE 5



COMMON CONDITIONS FOR ALL CIRCUITS

$E_g = 6.3$ VOLTS
 $+B = 250$ VOLTS D-C APPROXIMATE
 $R_k = 3300$ OHMS

$R_{ps} = 1.0$ MEGOHM
 $C = 0.05$ MICROFARAD

PATTERN RESPONSE IN VARIOUS CIRCUITS

CONTROL VOLTAGE SOURCE	SIGNAL	CIRCUIT (SEE FIGURE)	OFF CHANNEL (-)	ON CHANNEL OFF TUNE (-)	ON TUNE	ON CHANNEL OFF TUNE (+)	OFF CHANNEL (+)
DISCRIMINATOR	FM	1 AND 2					
DISCRIMINATOR AND SQUELCH	FM	3					
DISCRIMINATOR AND LIMITER	FM	4					
AVC	AM	5					

SYLVANIA RADIO TUBES

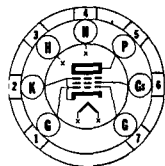

7BZ-0-0



Sylvania Type 6AQ5

BEAM POWER AMPLIFIER

PHYSICAL SPECIFICATIONS

Base.....	Miniature Button 7-Pin
Bulb.....	T-5 1/2"
Maximum Overall Length.....	2 5/8"
Maximum Seated Height.....	2 3/8"
Mounting Position.....	Any

RATINGS

Heater Voltage AC or DC.....	6.3 Volts
Heater Current.....	450 Ma.
Maximum Plate Voltage.....	250 Volts
Maximum Screen Voltage.....	250 Volts
Maximum Plate Dissipation.....	12 Watts
Maximum Screen Dissipation.....	2 Watts
Maximum Peak Heater-Cathode Voltage.....	90 Volts
Maximum Grid-Circuit Resistance	
For Fixed Bias.....	0.1 Megohm
For Cathode Bias.....	0.5 Megohm

Direct Interelectrode Capacitances:

	Shielded†	Unshielded
Grid to Plate.....	0.17	0.35 μ f.
Input.....	8.0	7.6 μ f.
Output.....	11.0	6.0 μ f.

†With a 1/4" diameter shield (RMA Std. 316) connected to Cathode.

TYPICAL OPERATION

AF POWER AMPLIFIER - CLASS A₁

Heater Voltage.....	6.3	6.3 Volts
Heater Current.....	450	450 Ma.
Plate Voltage.....	180	250 Volts
Screen Voltage.....	180	250 Volts
Control Grid Voltage.....	-8.5	-12.5 Volts
Peak AF Grid Voltage.....	8.5	12.5 Volts
Zero Signal Plate Current.....	29	45 Ma.
Maximum Signal Plate Current.....	30	47 Ma.
Zero Signal Screen Current (Approx.).....	3	4.5 Ma.
Maximum Signal Screen Current (Approx.).....	4	7 Ma.
Plate Resistance (Approx.).....	58,000	52,000 Ohms
Transconductance.....	3700	4100 μ mhos
Load Resistance.....	5500	5000 Ohms
Total Harmonic Distortion.....	8	8 %
Maximum Signal Power Output.....	2.0	4.5 Watts

AF POWER AMPLIFIER - CLASS AB₁*

Plate Voltage.....	250 Volts
Screen Voltage.....	250 Volts
Control Grid Voltage.....	-15 Volts
Peak AF Grid to Grid Voltage.....	30 Volts
Zero Signal Plate Current.....	70 Ma.
Maximum Signal Plate Current.....	79 Ma.
Zero Signal Screen Current.....	5 Ma.
Maximum Signal Screen Current.....	13 Ma.
Plate Resistance (per tube).....	60,000 Ohms
Transconductance (per tube).....	3750 μ mhos
Effective Load Resistance (plate to plate).....	10,000 Ohms
Total Harmonic Distortion.....	5 %
Maximum Signal Power Output.....	10 Watts

*Values are for two tubes.

APPLICATION

Sylvania Type 6AQ5 is a beam power amplifier in the miniature style designed for use in compact AC or auto sets. Since it is identical to Type 6V6GT except that the highest rating is not recommended, the same characteristic curves may be used. These are shown with Sylvania Type 7C5.

6AQ6 Sylvania Type

DUODIODE HIGH-MU TRIODE

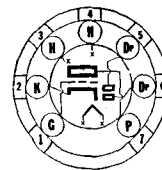

7BT-0-0

PHYSICAL SPECIFICATIONS

Base.....	Miniature Button 7 Pin
Bulb.....	T5 1/2
Maximum Overall Length.....	2 1/4"
Maximum Seated Height.....	1 3/8"
Mounting Position.....	Any

RATINGS

Heater Voltage AC or DC.....	6.3 Volts
Heater Current.....	150 Ma.
Maximum Plate Voltage.....	300 Volts
Maximum Heater-Cathode Voltage.....	90 Volts

TYPICAL OPERATION

CLASS A₁ AMPLIFIER

Heater Voltage.....	6.3	6.3 Volts
Heater Current.....	150	150 Ma.
Plate Voltage.....	100	250 Volts
Grid Voltage.....	-1.0	-3.0 Volts
Amplification Factor.....	70	70
Plate Resistance.....	61000	58000 Ohms
Mutual Conductance.....	1150	1200 μ mhos
Plate Current.....	0.8	1.0 Ma.

APPLICATION

Sylvania Type 6AQ6 is a double diode, high-mu triode of miniature construction. It is similar to type 6Q7 but has lower heater drain and lower internal capacitances. Its small size facilitates the design of small compact receivers.

Data for use in Resistance Coupled Amplifier Circuits may be found in the appendix under type 6Q7GT.

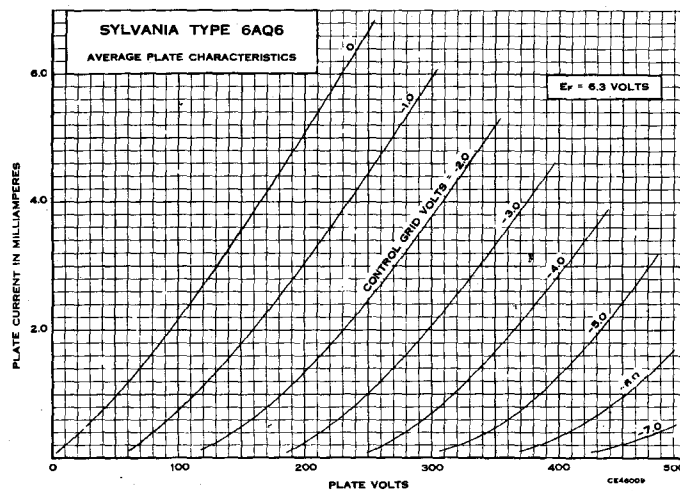

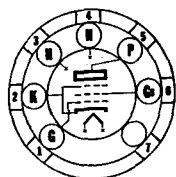

6CC-0-0

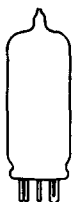

Sylvania Type 6AR5

BEAM POWER AMPLIFIER

PHYSICAL SPECIFICATIONS

Base	Miniature Button 7 Pin
Bulb	T-5½
Maximum Overall Length	2 5/8"
Maximum Seated Height	2 3/8"
Mounting Position	Any

RATINGS

Heater Voltage AC or DC	6.3 Volts
Maximum Plate Voltage	250 Volts
Maximum Screen Voltage	250 Volts
Maximum Plate Dissipation	8.5 Watts
Maximum Screen Dissipation	2.5 Watts
Maximum Heater-Cathode Voltage	90 Volts

TYPICAL OPERATION

Heater Voltage AC or DC	6.3	6.3 Volts
Heater Current	400	400 Ma.
Plate Voltage	250	250 Volts
Screen Voltage	250	250 Volts
Grid Voltage*	-16.5	-18 Volts
Self-Bias Resistor	420	500 Ohms
Peak Signal Voltage	16.5	18 Volts
Plate Current (Zero Signal)	34	32 Ma.
Plate Current (Maximum Signal)	35	33 Ma.
Screen Current (Zero Signal)	5.7	5.5 Ma.
Screen Current (Maximum Signal)	10	10 Ma.
Plate Resistance (Approx.)	65,000	68,000 Ohms
Mutual Conductance	2,400	2,300 μmhos
Load Resistance	7,000	7,600 Ohms
Power Output	3.2	3.4 Watts
Total Harmonic Distortion	7	11 %

*Maximum grid circuit resistance should not exceed 0.5 megohms for self-bias operation, or 0.1 megohm for fixed bias operation.

APPLICATION

Sylvania Type 6AR5 is a miniature tube for use in locations where the space requirements do not permit use of the Types 7B5 or 6K6G, and which do not require the 315 volt rating. For curve data, reference should be made to Type 7B5.

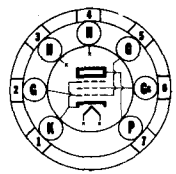

7CV-0-0



Sylvania Type 6AS5

BEAM POWER AMPLIFIER

PHYSICAL SPECIFICATIONS

Base	Miniature Button 7-Pin
Bulb	T-5½
Maximum Overall Length	2 5/8"
Maximum Seated Height	2 3/8"
Mounting Position	Any

RATINGS

Heater Voltage AC or DC	6.3 Volts
Maximum Plate Voltage	150 Volts
Maximum Screen Voltage	117 Volts
Maximum Plate Dissipation	5.5 Watts
Maximum Screen Dissipation	1.0 Watt
Maximum Heater-Cathode Voltage	90 Volts

Direct Interelectrode Capacitances: (approx.)*

Grid No. 1 (Control Grid) to Plate	0.6 μf.
Input	12 μf.
Output	6.2 μf.

*With no external shield.

6AS5 (Cont'd)

TYPICAL OPERATION CLASS A₁ AMPLIFIER

Heater Voltage	6.3 Volts
Heater Current	0.8 Ampere
Plate Voltage	150 Volts
Screen Voltage	110 Volts
Control Grid Voltage*	-8.5 Volts
Peak AF Grid Voltage	8.5 Volts
Plate Current (Zero Signal)	35 Ma.
Plate Current (Maximum Signal)	36 Ma.
Screen Current (Zero Signal)	2 Ma.
Screen Current (Maximum Signal)	6.5 Ma.
Mutual Conductance	5600 μ mhos
Load Resistance	4500 Ohms
Power Output (Maximum Signal)	2.2 Watts
Total Harmonic Distortion	10 %

*Maximum grid circuit resistance should not exceed 0.5 megohm for self bias operation, or 0.1 megohm for fixed bias operation.

APPLICATION

Sylvania Type 6AS5, a miniature beam power amplifier, is used in the output stage of automobile and ac operated receivers. It delivers relatively large power output at low plate and screen voltages.

6AS6 Sylvania Type PENTODE WITH SUPPRESSOR CONTROL



7CM-0-0

PHYSICAL SPECIFICATIONS

Base	Miniature Button 7-Pin
Bulb	T-5 $\frac{1}{2}$
Maximum Overall Length	1 $\frac{3}{4}$ "
Maximum Seated Height	1 $\frac{1}{2}$ "
Mounting Position	Any

RATINGS

Heater Voltage AC or DC	6.3 Volts
Heater Current	175 Ma.
Maximum Plate Voltage	180 Volts
Maximum Screen Voltage	140 Volts
Maximum Plate Dissipation	1.7 Watts
Maximum Screen Dissipation	0.75 Watt
Maximum Peak Heater-Cathode Voltage	90 Volts
Maximum Cathode Current	18 Ma.

Direct Interelectrode Capacitances:

	Unshielded	Shielded*
Grid to Plate	0.025	0.02 μ mf.
Input	3.9	4.0 μ mf.
Output	2.2	3.0 μ mf.

*External shield connected to pin #2 (cathode.)

TYPICAL OPERATION

Heater Voltage	6.3	6.3 Volts
Heater Current	175	175 Ma.
Plate Voltage	120	120 Volts
Screen Voltage	120	120 Volts
Suppressor Voltage	-3	0 Volts
Control Grid Voltage	-2	-2 Volts
Plate Current	3.6	5.2 Ma.
Screen Current	4.8	3.5 Ma.
Mutual Conductance, Control-Grid	1850	3200 μ mhos
Mutual Conductance, Suppressor Grid	810	470 μ mhos

APPLICATION

Sylvania Type 6AS6 is a miniature pentode intended for low power applications at high and ultra-high frequencies. It can be used in delay circuits, mixers, gain controlled amplifiers, and gated amplifiers. The control grid and suppressor grid can be used as individual control elements.

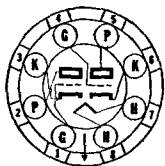

8BD-0-0

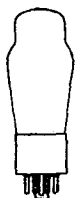

Sylvania Type 6AS7G

LOW MU DUOTRIODE

PHYSICAL SPECIFICATIONS

Base.....	Medium Shell Octal 8 Pin
Bulb.....	ST-16
Maximum Overall Length.....	5 $\frac{1}{2}$ "
Maximum Seated Height.....	4 $\frac{3}{4}$ "
Mounting Position.....	Any

RATINGS

Heater Voltage AC or DC.....	6.3 Volts
Heater Current.....	2.5 Amperes
Maximum Plate Voltage.....	250 Volts
Maximum Plate Dissipation per Plate.....	13 Watts
Maximum Peak Heater-Cathode Voltage.....	300 Volts
Maximum Peak Inverse Plate Voltage.....	1700 Volts
Maximum Plate Current.....	125 Ma.

TYPICAL OPERATION

AS A DIRECT COUPLED AMPLIFIER

Plate Supply Voltage.....	135 Volts
Grid Voltage.....	Obtained by Self-Bias Resistor
Self-Bias Resistor.....	250 Ohms
Plate Current.....	125 Ma.
Plate Resistance.....	280 Ohms
Mutual Conductance.....	7000 μ mhos
Amplification Factor.....	2.0

APPLICATION

Sylvania Type 6AS7G is a low mu duo triode power amplifier designed for television service as a booster scanner. Fixed bias operation is not recommended and the grid circuit resistance should not exceed 1 megohm.

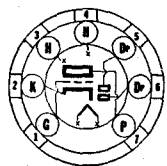

7BT-0-0



Sylvania Type 6AT6

DUODIODE HIGH-MU TRIODE

PHYSICAL SPECIFICATIONS

Base.....	Miniature Button 7 Pin
Bulb.....	T5 $\frac{1}{2}$
Maximum Overall Length.....	2 $\frac{1}{4}$ "
Maximum Seated Height.....	1 $\frac{1}{8}$ "
Mounting Position.....	Any

RATINGS

Heater Voltage AC or DC.....	6.3 Volts
Heater Current.....	300 Ma.
Maximum Plate Voltage.....	300 Volts
Maximum Heater-Cathode Voltage.....	90 Volts
Direct Interelectrode Capacitances:*	
Grid to Plate.....	2.1 μ f.
Input.....	2.3 μ f.
Output.....	1.1 μ f.
Diode No. 2 (Pin 5) to Grid.....	025 μ f. Max.

*Without external shield.

TYPICAL OPERATION

Heater Voltage.....	6.3	6.3 Volts
Heater Current.....	300	300 Ma.
Plate Voltage.....	100	250 Volts
Grid Voltage.....	-1.0	-3.0 Volts
Plate Current.....	0.8	1.0 Ma.
Amplification Factor.....	70	70
Plate Resistance.....	54000	58000 Ohms
Mutual Conductance.....	1300	1200 μ mhos

Data for use in Resistance Coupled Amplifier Circuits may be found in the appendix under type 6Q7GT.

6AT6 (Cont'd)

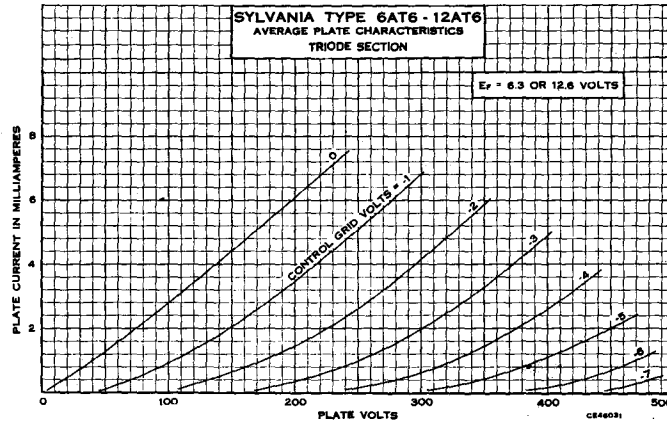

6AU5^{GT} Sylvania Type

BEAM POWER AMPLIFIER
TELEVISION SCANNER

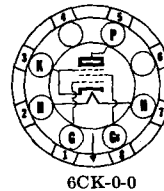

PHYSICAL SPECIFICATIONS

Base	Intermediate Octal 6-Pin
Bulb	T-9
Maximum Overall Length	3 ⁵ / ₁₆ "
Maximum Seated Height	2 ³ / ₄ "
Mounting Position	Any

RATINGS

Heater Voltage (AC or DC)	6.3 Volts
Heater Current	1.25 Amperes
Maximum Plate Voltage	450 Volts
Maximum Screen Voltage	200 Volts
Maximum Plate Dissipation	10 Watts
Maximum Peak Heater-Cathode Voltage	±180 Volts

Direct Interelectrode Capacitances*

Grid to Plate	0.5 $\mu\text{f.}$
Input	11.3 $\mu\text{f.}$
Output	7.0 $\mu\text{f.}$

*Without external shield.

TYPICAL OPERATION**HORIZONTAL DEFLECTION AMPLIFIER****

Heater Voltage (AC or DC).....	6.3 Volts
Heater Current.....	1.25 Amperes
Plate Voltage†.....	450 Volts
Screen Voltage.....	167 Volts
Peak Positive-Surge Plate Voltage.....	4500 Volts
Peak Positive Grid Signal (Sawtooth).....	85 Volts
Peak Negative Grid Signal (Sawtooth).....	15 Volts
Plate Current.....	71 Ma.
Screen Current.....	6 Ma.
Developed High Voltage.....	12.0 K Volts

**Circuit used for these data is that given for Type 6BQ6GT.

†This voltage consists of 325 volts from DC power supply plus boost from the damper circuit.

APPLICATION

Sylvania Type 6AU5GT is a beam power amplifier designed especially for use as a horizontal scanner in television receivers using magnetic deflection. For typical circuit see deflection amplifier circuit given for Type 6BQ6GT which uses a "fly-back" type high voltage supply.

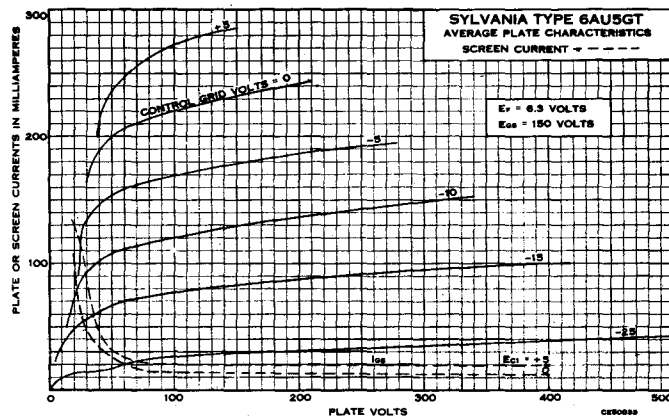

6AU6 Sylvania Type

SHARP CUT-OFF RF PENTODE

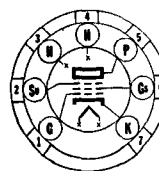

7BK-0-2

PHYSICAL SPECIFICATIONS

Base.....	Miniature Button 7 Pin
Bulb.....	T5 1/2
Maximum Overall Length.....	2 1/2"
Maximum Seated Height.....	1 1/8"
Mounting Position.....	Any

RATINGS

Heater Voltage AC or DC.....	6.3 Volts
Heater Current.....	300 Ma.
Maximum Plate Voltage.....	300 Volts
Maximum Screen Voltage.....	150 Volts
Maximum Screen Supply Voltage.....	300 Volts
Maximum Plate Dissipation.....	3 Watts
Maximum Screen Dissipation.....	0.65 Watt
Minimum Control Grid Voltage.....	0 Volt
Maximum Heater-Cathode Voltage.....	90 Volts

Direct Interelectrode Capacitances:*

Grid to Plate.....	0.0035 μ f. Max.
Input.....	5.5 μ f.
Output.....	5.0 μ f.

*Without external shield.

TYPICAL OPERATION

Heater Voltage.....	6.3	6.3	6.3 Volts
Heater Current.....	300	300	300 Ma.
Plate Voltage.....	100	250	250 Volts
Suppressor Grid.....			Connect to Cathode at Socket
Screen Voltage.....	100	125	150 Volts
Control Grid Voltage.....	-1.0	-1.0	-1.0 Volt
Cathode Resistor.....	150	100	68 Ohms
Plate Resistance (Approximate).....	0.5	1.5	1.0 Megohm
Mutual Conductance.....	3900	4500	5200 μ mhos
Control Grid Voltage at 10 μ a. Plate.....	-4.2	-5.5	-6.5 Volts
Plate Current.....	5.0	7.6	10.6 Ma.
Screen Current.....	2.1	3.0	4.3 Ma.

APPLICATION

Sylvania Type 6AU6 is a sharp cut-off pentode of miniature construction. It has high mutual conductance and low interelectrode capacitances. These characteristics combined with high plate resistance make it suitable for many RF and IF applications. The miniature type of construction lends itself readily to applications in compact light-weight equipment.

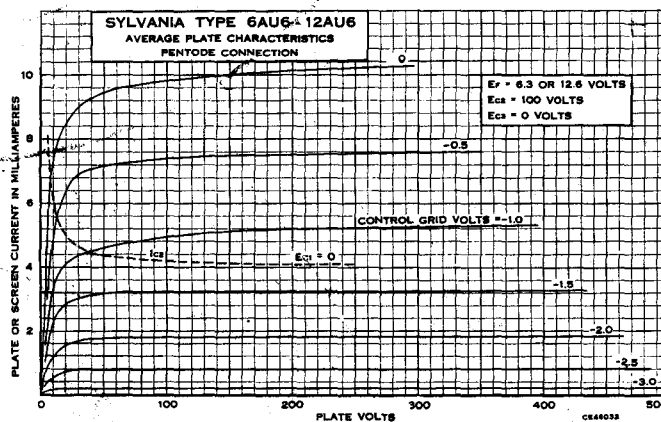

SYLVANIA RADIO TUBES

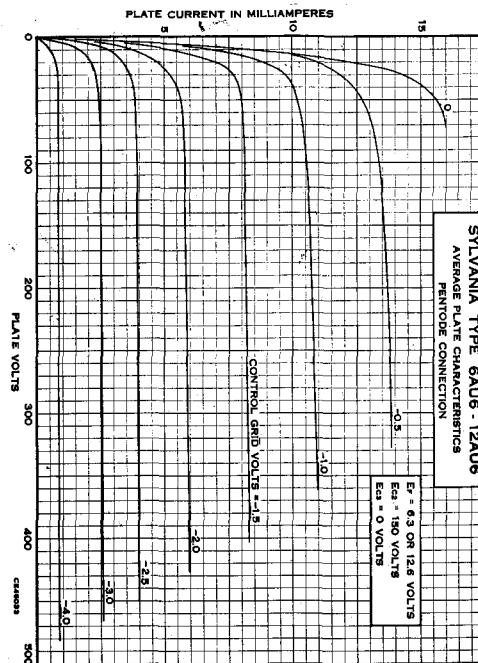
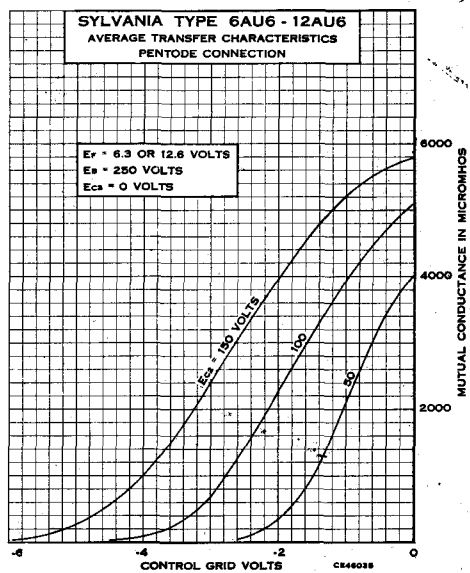
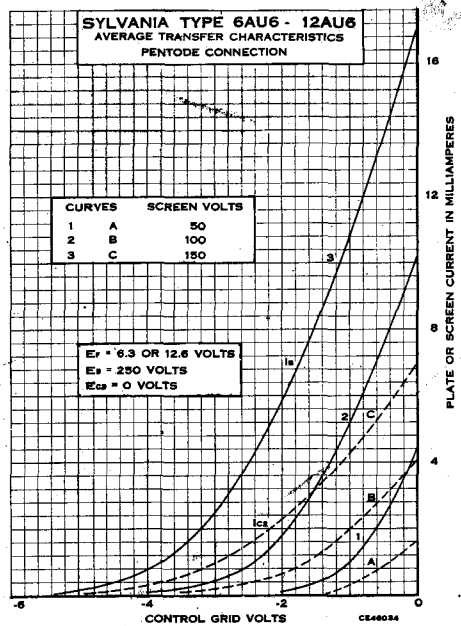

6AV5^{GT} Sylvania Type

BEAM POWER AMPLIFIER
TELEVISION SCANNER

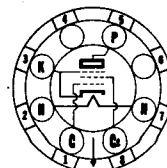

6CK-0-0

PHYSICAL SPECIFICATIONS

Base	Intermediate Octal 6-Pin
Bulb	T-9
Maximum Overall Length	3 ⁵ / ₁₆ "
Maximum Seated Height	2 ³ / ₄ "
Mounting Position	Any

RATINGS

Heater Voltage (AC or DC)	6.3 Volts
Heater Current	1.2 Amperes
Maximum Plate Supply Voltage	550 Volts
Maximum Screen Voltage	200 Volts
Maximum Peak Positive-Surge Plate Voltage*	5500 Volts
Maximum Negative Control Grid Voltage	100 Volts
Maximum Peak Negative-Surge Control Grid Voltage*	400 Volts
Maximum DC Plate Current	100 Ma.
Maximum Screen Dissipation	2.5 Watts
Maximum Plate Dissipation	11 Watts
Maximum Control Grid Circuit Resistance*	1 Megohm
Maximum Peak Heater-Cathode Voltage	180 Volts

*Absolute maximum value which must not be exceeded under any condition of operation. The duration of the voltage pulse should not exceed 15% of one horizontal scanning cycle. In a 525 line, interlaced two to one, 30 frame per second television system, 15% of one vertical scanning cycle is 10 microseconds.

* As a protection against loss of excitation and resulting loss of developed bias a cathode resistor or other suitable device must be employed.

TYPICAL OPERATION**

HORIZONTAL DEFLECTION AMPLIFIER

Heater Voltage (AC or DC)	6.3 Volts
Heater Current	1.2 Amperes
Plate Voltage†	460 Volts
Screen Voltage	136 Volts
Peak Positive-Surge Plate Voltage	4400 Volts
Peak Positive Grid Signal (Sawtooth)	65 Volts
Peak Negative Grid Signal (Sawtooth)	35 Volts
Plate Current	78 Ma.
Screen Current	7 Ma.
Developed High Voltage	12.0 K Volts

**Circuit used for these data is that given for Type 6BQ6GT.

†This voltage consists of 325 volts from DC power supply plus boost from the damper circuit.

APPLICATION

Sylvania Type 6AV5GT is a beam power amplifier designed especially for use as a horizontal scanner tube in television receivers using magnetic deflection. The typical operating conditions shown above may be obtained by using the circuit given for Type 6BQ6GT. This provides sufficient scan for use with a Sylvania Type 16TP4 picture tube.

(Cont'd) **6AV5GT**

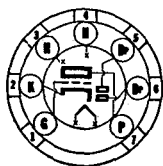
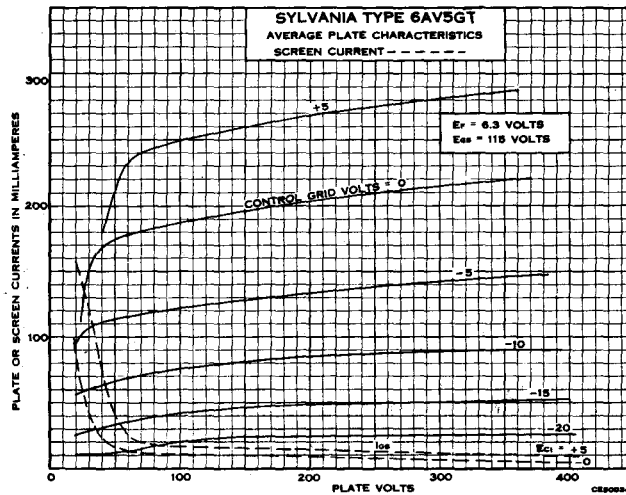

7BT-0-0



Sylvania Type **6AV6**

DUODIODE TRIODE

PHYSICAL SPECIFICATIONS

Base.....	Small Button Miniature 7 Pin
Bulb.....	T-5 $\frac{1}{2}$
Maximum Overall Length.....	2 $\frac{1}{2}$ "
Maximum Seated Height.....	1 $\frac{1}{2}$ "
Mounting Position.....	Any

RATINGS

Heater Voltage AC or DC.....	6.3 Volts
Heater Current.....	300 Ma.
Maximum Plate Voltage (Triode Unit).....	300 Volts
Maximum Peak Heater-Cathode Voltage.....	90 Volts
Maximum Diode Plate Current per diode.....	1.0 Ma.

6AV6 (Cont'd)

TYPICAL OPERATION TRIODE UNIT - CLASS A₁ AMPLIFIER

Heater Voltage.....	6.3	6.3 Volts
Heater Current.....	300	300 Ma.
Plate Voltage.....	100	250 Volts
Grid Voltage.....	-1	-2 Volts
Amplification Factor.....	100	100
Plate Resistance.....	80,000	62,500 Ohms
Transconductance.....	1250	1600 μ mhos
Plate Current.....	0.5	1.2 Ma.

APPLICATION

Sylvania Type 6AV6 is a high μ diode triode in the miniature style. It is very similar in characteristics to lock-in Type 7B4 and the resistance coupled data given in appendix will be substantially correct for this type also. Type 12AV6 is the 150 Ma. equivalent for use in AC-DC sets.

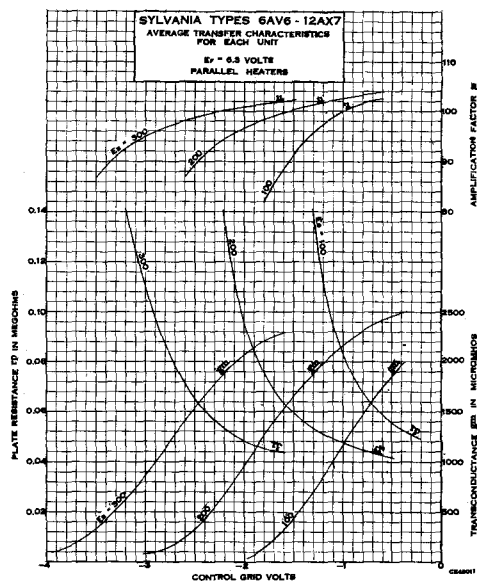
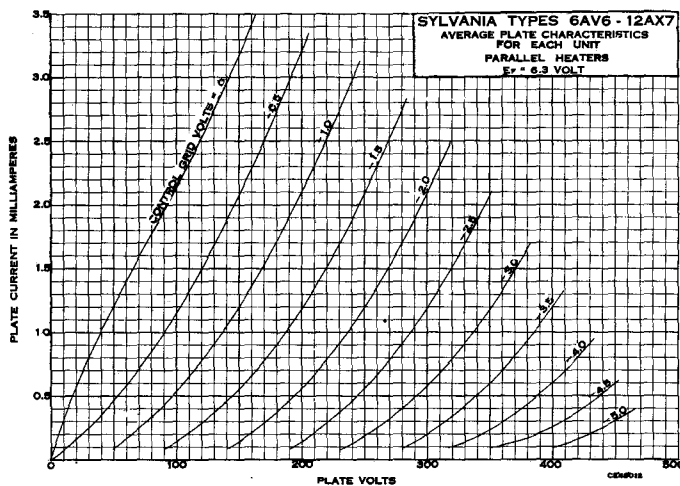

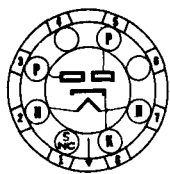

6S-0-0

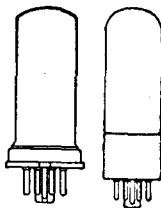

Sylvania Type 6AX5^{GT}

FULL-WAVE RECTIFIER

PHYSICAL SPECIFICATIONS

Base.....	Intermediate Octal 6-Pin
Bulb.....	T-9
Maximum Overall Length.....	3 $\frac{5}{8}$ "
Maximum Seated Height.....	2 $\frac{3}{4}$ "
Mounting Position.....	Any

RATINGS

Heater Voltage AC or DC.....	6.3 Volts
Heater Current.....	1.2 Amperes
Maximum Peak Inverse Plate Voltage.....	1250 Volts
Maximum Peak Heater-Cathode Voltage.....	450 Volts
Maximum Peak Plate Current (per plate).....	375 Ma.

TYPICAL OPERATION

CONDENSER INPUT TO FILTER

AC Voltage per Plate (RMS).....	350	450 Volts
Plate Supply Impedance per Plate.....	50	105 Ohms
Filter Input Capacitor.....	10	10 μ f.
DC Output Voltage at Input to Filter (approx.)		
At Half-Load Current of 62.5 Ma.....	395	... Volts
40 Ma.....		540 Volts
At Full-Load Current of 125 Ma.....	350	... Volts
80 Ma.....		490 Volts

CHOKE INPUT TO FILTER

AC Voltage per Plate (RMS).....	350	450 Volts
Filter Input Choke.....	10	10 Henries
DC Output Voltage at Input to Filter (approx.)		
At Half-Load Current of 75 Ma.....	270	... Volts
62.5 Ma.....		365 Volts
At Full-Load Current of 150 Ma.....	250	... Volts
125 Ma.....		350 Volts

APPLICATION

Sylvania Type 6AX5GT is a full-wave rectifier featuring the unipotential cathode. It is designed for use in ac operated receivers and automobile receivers.

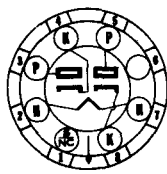

7Q-0-0



Sylvania Type 6AX6^G

FULL WAVE RECTIFIER

PHYSICAL SPECIFICATIONS

Base.....	Medium Octal 7-Pin
Bulb.....	ST-14
Maximum Overall Length.....	4 $\frac{3}{8}$ "
Maximum Seated Height.....	4 $\frac{1}{16}$ "
Mounting Position.....	Any

RATINGS

Heater Voltage AC or DC.....	6.3 Volts
Maximum Peak Inverse Voltage (per plate).....	1250 Volts
Rectifier Operation.....	1250 Volts
Damper Operation*.....	2000 Volts
Maximum Heater-Cathode Voltage	
Heater Negative With Respect to Cathode.....	450 Volts
Heater Positive With Respect to Cathode.....	100 Volts
Maximum Peak Plate Current per Plate.....	600 Ma.
Maximum DC Output Current per Plate.....	125 Ma.

*Duration of voltage pulse not to exceed 15% of each scanning cycle. In the 525 line, 30 frame television system 15% of one scanning cycle is 10 microseconds.

SYLVANIA RADIO TUBES

6AX6^G (Cont'd)

TYPICAL OPERATION

FULL WAVE RECTIFIER — CONDENSER INPUT

Heater Voltage AC or DC.....	6.3 Volts
Heater Current.....	2.5 Amperes
AC Plate Voltage per Plate (RMS).....	350 Volts
DC Output Current.....	250 Ma.
Total Effective Plate Supply Impedance per Plate (Min.).....	145 Ohms
DC Output Voltage at Input to Filter (approx.)	
At 1/4 Load (125 Ma.).....	395 Volts
At Full Load (250 Ma.).....	350 Volts

APPLICATION

Sylvania Type 6AX6G is a full wave rectifier featuring the coated unipotential cathode. It is suitable for damper-diode service in television deflection circuits or as a rectifier in conventional power supply applications.

6B4G Sylvania Type

POWER AMPLIFIER TRIODE

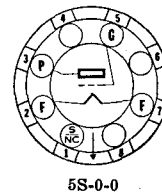

5S-0-0

PHYSICAL SPECIFICATIONS

Base.....	Medium Octal 8 Pin
Bulb.....	ST16
Maximum Overall Length.....	5 5/16"
Maximum Seated Height.....	4 3/4"
Mounting Position.....	Any

RATINGS

Filament Voltage.....	6.3 Volts
Filament Current.....	1.0 Ampere
Maximum Plate Voltage.....	325 Volts

Direct Interelectrode Capacitances:*

Grid to Plate.....	16 μ f.
Input.....	7 μ f.
Output.....	5 μ f.

*Without external shield.

TYPICAL OPERATION AS AMPLIFIER

	Class A One Tube	Push Pull Class AB Fixed Bias	Two Tubes Self Bias
Filament Voltage.....	6.3	6.3	6.3 Volts
Filament Current.....	1.0	1.0	1.0 Ampere
Plate Voltage.....	250	325	325 Volts
Grid Voltage*.....	-45	-68	Volts
Self-Bias Resistor.....	750		850 Ohms
Plate Current (Per Tube).....	60	40	40 Ma.
Plate Resistance.....	800		Ohms
Mutual Conductance.....	5250		μ mhos
Amplification Factor.....	4.2		
Total Load Resistance.....	2500	3000	5000 Ohms
Power Output.....	3.2	15	10 Watts
Harmonic Distortion.....	5.0	2.5	5.0 Per Cent

*Measured from filament center tap when operated on AC.

APPLICATION

Sylvania 6B4G is a power amplifier triode, identical to Type 6A3 in electrical characteristics, and is used in the output stage of a-c operated receivers and public address systems.

Any of the conventional methods may be used for the input coupling provided that the resistance added in the grid return is not excessive. The d-c resistance in this circuit should be less than 0.5 megohm for a self-bias arrangement; with fixed bias the limit is 50,000 ohms. If the above values are exceeded, the bias voltage may be reduced as a result of grid current. This condition will cause excessive plate current to flow which, in turn, may cause damage to the tube or output transformer.